

## ZF 63

Vertical offset, direct mount marine transmission.

### Description

- Reverse reduction marine transmission with hydraulically actuated multi-disc clutches .
- Suitable for high performance applications in luxury motoryachts, sport fishers, express cruisers etc .
- Robust design also withstands continuous duty in workboat applications .
- Fully works tested, reliable and simple to install .
- Design, manufacture and quality control standards comply with ISO 9001 .
- Compatible with all types of engines and propulsion systems, including waterjets and surface- piercing propellers, as applicable .

### Features

- Lightweight and robust aluminum alloy casing (sea water resistant) .
- Case hardened and precisely ground gear teeth for long life and smooth running .
- Output shaft thrust bearing designed to take maximum propeller thrust astern and ahead .
- B/W connection integrated with casing .
- Smooth and reliable hydraulic shifting with control lever for attachment of push-pull cable .
- Suitable for twin engine installations (same torque capacity in ahead or astern mode. Reduction Ratios in ahead or astern are very close.) .
- Replaceable oil filter cartridge .
- "SUPERSHIFT" clutch control .

### Options

- Engine-matched dual stage coupling .
- SAE 3 and SAE 4 bell housings .
- Oil cooler complete with fittings and flexible oil hoses .
- Mounting brackets .
- Propeller shaft flange .
- Control cable bracket for connection of the push-pull cable .
- Classification by all major Classification Societies on request .
- SAE «A» Power Take Off .
- Thermostatic valve for better performance of trolling valve in cold sea water .
- Trolling valve (mechanical) for slow-speed drive .
- Electric Trolling .
- Supershift (with Autotroll and Easidock) .

# ZF 63 Ratings

## Pleasure Duty

	RATIOS		MAX. TORQUE		POWER/RPM		INPUT POWER CAPACITY						MAX. RPM
	'A' Pos	'B' Pos	Nm	ftlb	kW	hp	2800 rpm		3300 rpm		3800 rpm		
							kW	hp	kW	hp	kW	hp	
■	1.256	1.250	680	502	0.0712	0.0955	199	267	235	315	271	363	5500
■	1.514	1.521	680	502	0.0712	0.0955	199	267	235	315	271	363	5500
■	1.750*	1.770	680	502	0.0712	0.0955	199	267	235	315	271	363	5500
■	1.933	1.973	680	502	0.0712	0.0955	199	267	235	315	271	363	5500
■	2.480	2.476	564	416	0.0591	0.0792	165	222	195	261	224	301	5500
■	2.783	2.799	564	416	0.0591	0.0792	165	222	195	261	224	301	5500

'A' POS = continuous running position (normally AHEAD). 'B' POS = reverse position.

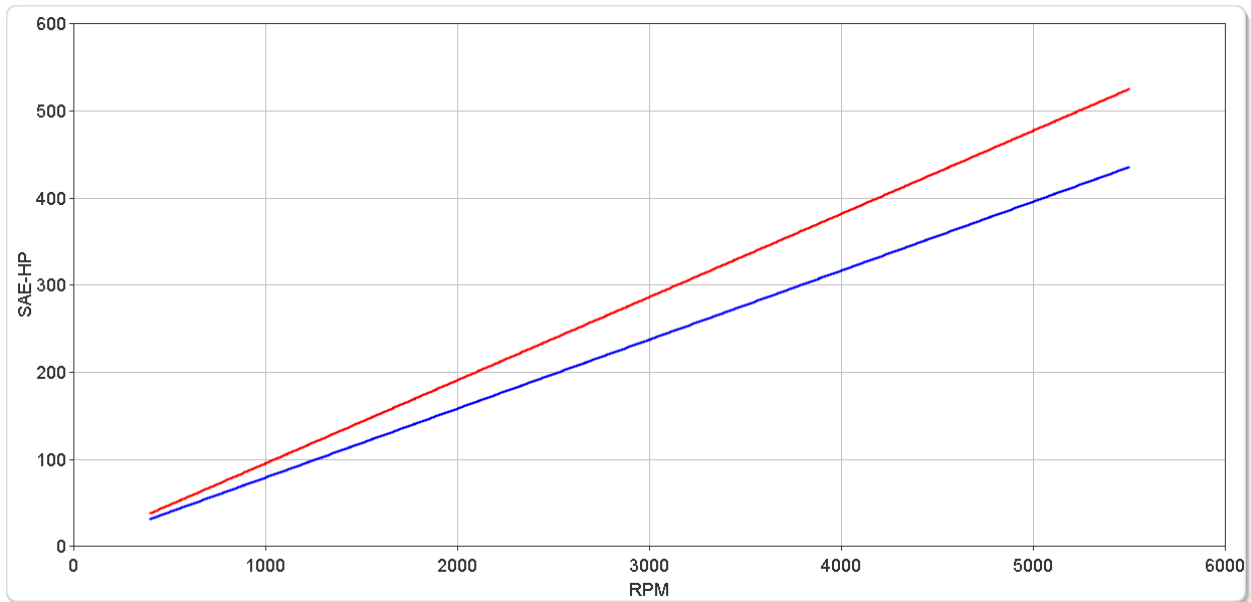
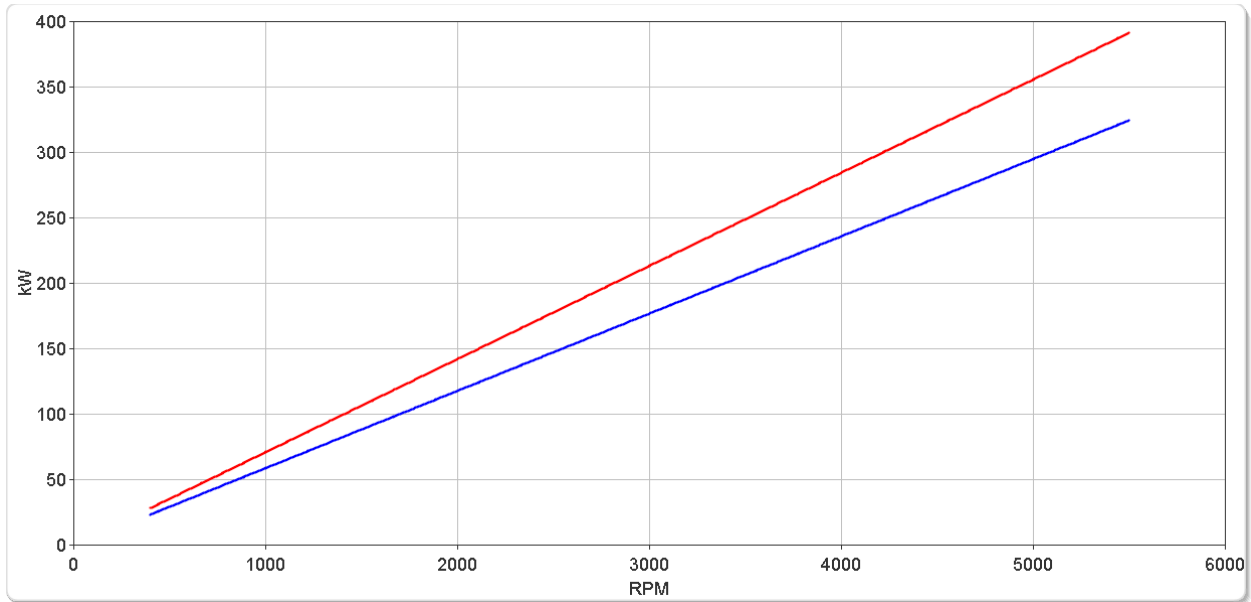

### Pleasure Duty Gasoline

	RATIOS		MAX. TORQUE		POWER/RPM		INPUT POWER CAPACITY						MAX. RPM
	'A' Pos	'B' Pos	Nm	ftlb	kW	hp	4000 rpm		4400 rpm		4800 rpm		
							kW	hp	kW	hp	kW	hp	
■	1.256	1.250	680	502	0.0712	0.0955	285	382	313	420	342	458	5500
■	1.514	1.521	680	502	0.0712	0.0955	285	382	313	420	342	458	5500
■	1.750*	1.770	680	502	0.0712	0.0955	285	382	313	420	342	458	5500
■	1.933	1.973	680	502	0.0712	0.0955	285	382	313	420	342	458	5500
■	2.480	2.476	564	416	0.0591	0.0792	236	317	260	348	283	380	5500
■	2.783	2.799	564	416	0.0591	0.0792	236	317	260	348	283	380	5500

\*'A' POS = continuous running position (normally AHEAD). 'B' POS = reverse position.

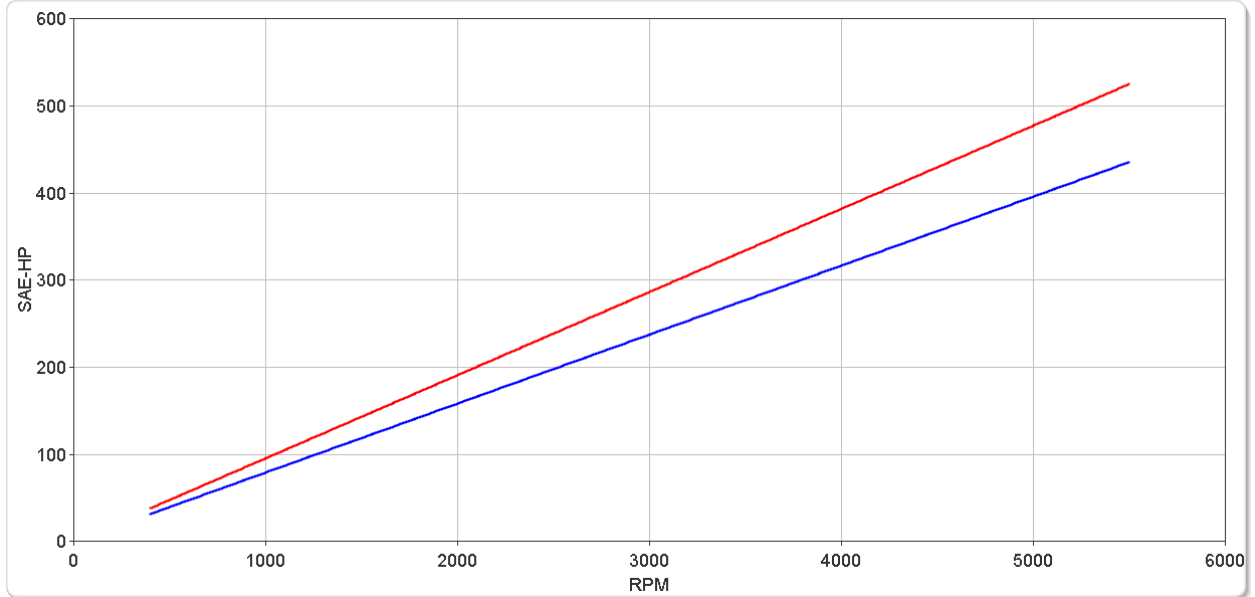
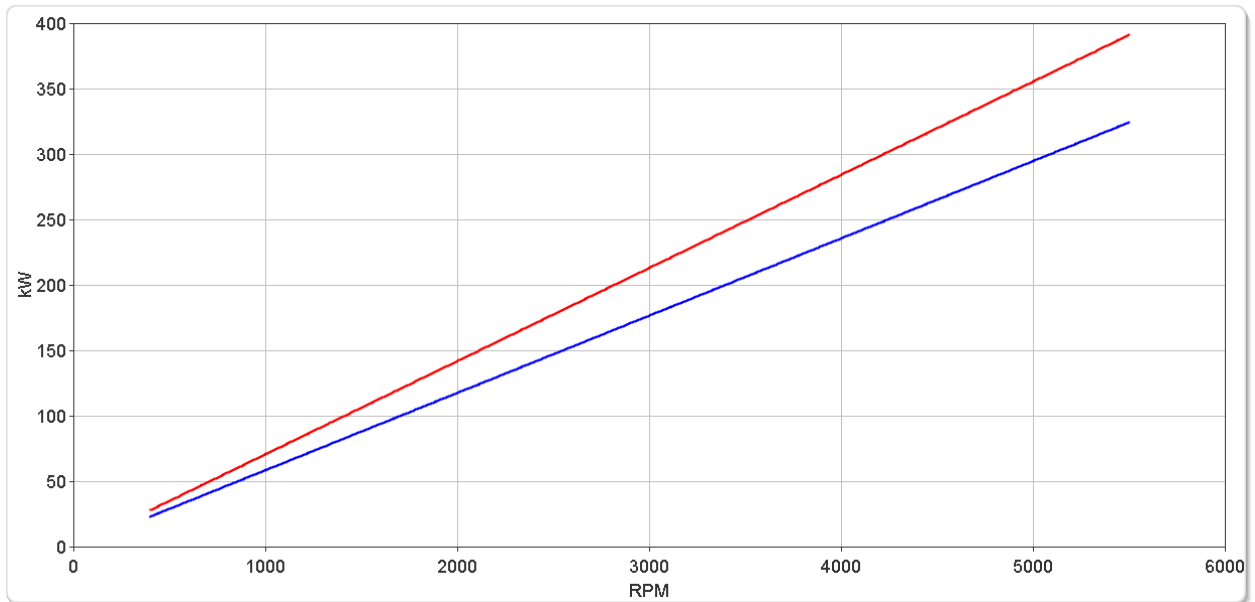

# ZF 63

## Ratings

### Light Duty

	RATIOS		MAX. TORQUE		POWER/RPM		INPUT POWER CAPACITY						MAX. RPM
	'A' Pos	'B' Pos	Nm	ftlb	kW	hp	2100 rpm		2500 rpm		2800 rpm		
							kW	hp	kW	hp	kW	hp	
■	1.256	1.250	647	477	0.0677	0.0909	142	191	169	227	190	254	5500
■	1.514	1.521	647	477	0.0677	0.0909	142	191	169	227	190	254	5500
■	1.750*	1.770	647	477	0.0677	0.0909	142	191	169	227	190	254	5500
■	1.933	1.973	647	477	0.0677	0.0909	142	191	169	227	190	254	5500
■	2.480	2.476	538	397	0.0563	0.0755	118	159	141	189	158	212	5500
■	2.783	2.799	538	397	0.0563	0.0755	118	159	141	189	158	212	5500

\*'A' POS = continuous running position (normally AHEAD). 'B' POS = reverse position.

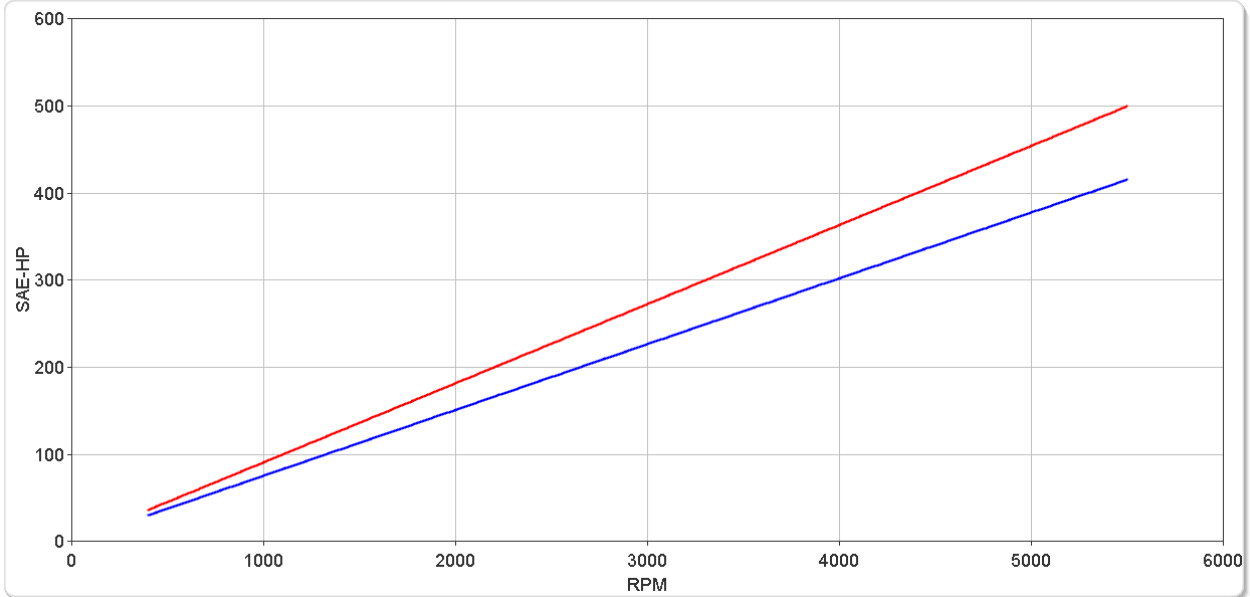
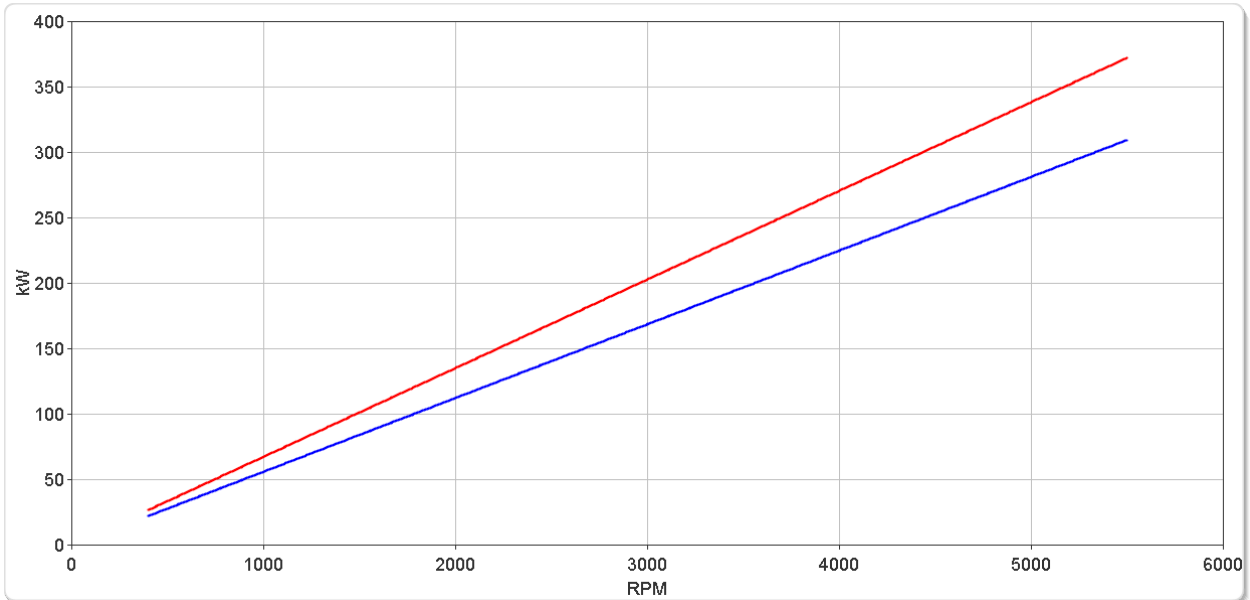

### Medium Duty

	RATIOS		MAX. TORQUE		POWER/RPM		INPUT POWER CAPACITY						MAX. RPM
	'A' Pos	'B' Pos	Nm	ftlb	kW	hp	2100 rpm		2500 rpm		2800 rpm		
							kW	hp	kW	hp	kW	hp	
■	1.256	1.250	515	380	0.0539	0.0723	113	152	135	181	151	202	5500
■	1.514	1.521	515	380	0.0539	0.0723	113	152	135	181	151	202	5500
■	1.750*	1.770	515	380	0.0539	0.0723	113	152	135	181	151	202	5500
■	1.933	1.973	515	380	0.0539	0.0723	113	152	135	181	151	202	5500
■	2.480	2.476	495	365	0.0518	0.0695	109	146	130	174	145	195	5500
■	2.783	2.799	495	365	0.0518	0.0695	109	146	130	174	145	195	5500

\*'A' POS = continuous running position (normally AHEAD). 'B' POS = reverse position.

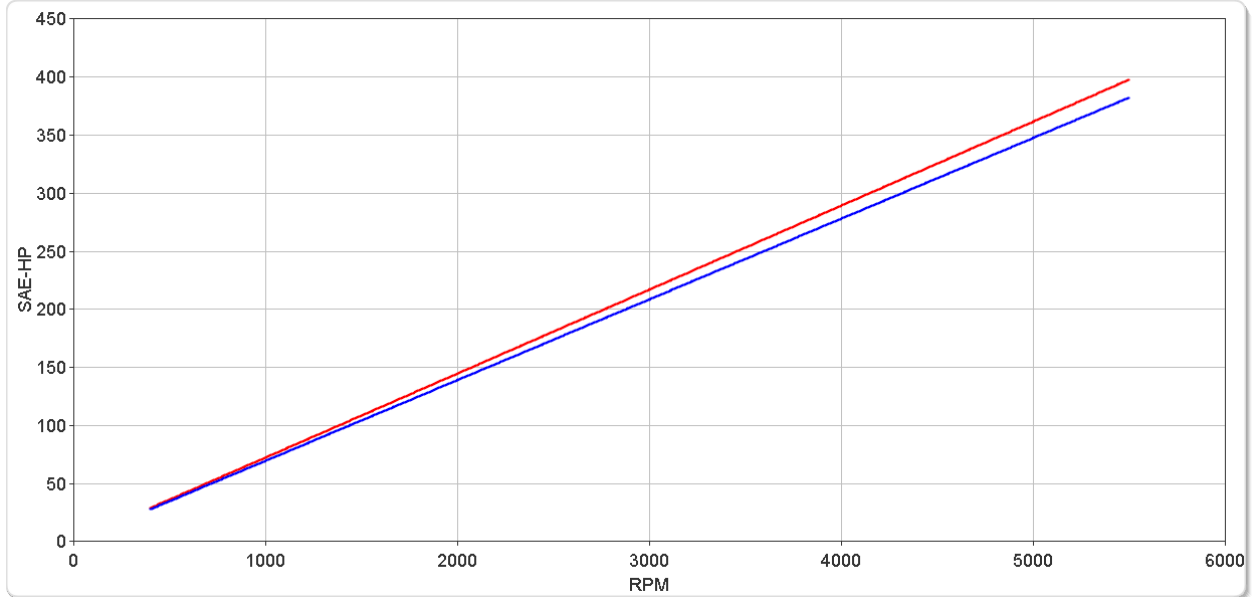
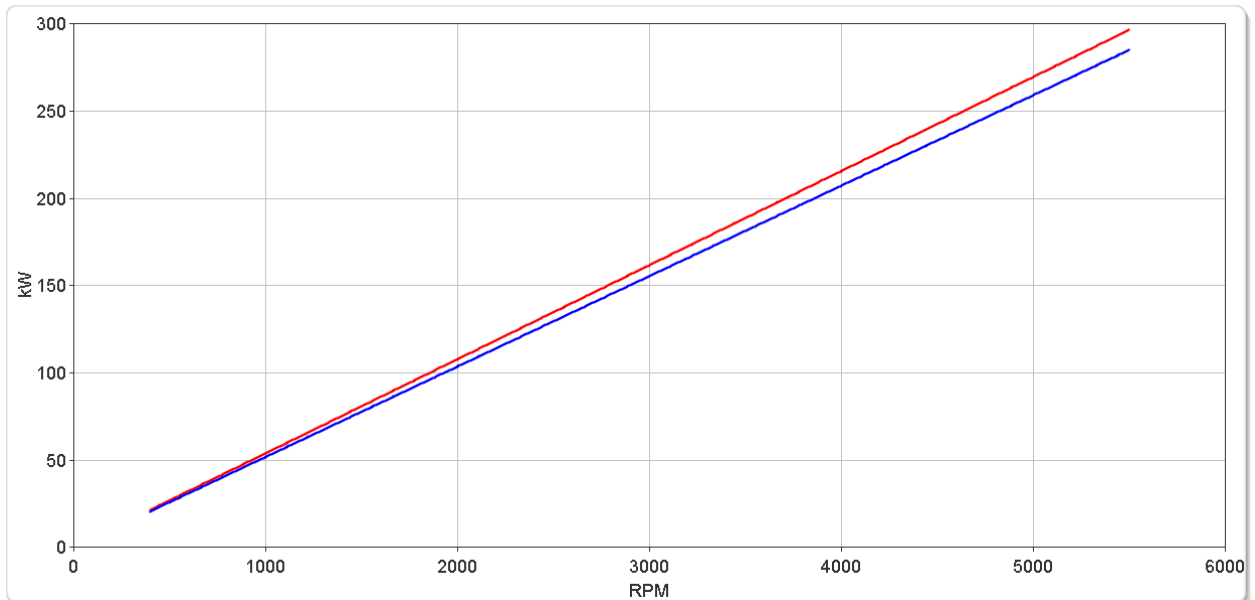

# ZF 63

## Ratings

### Continuous Duty

	RATIOS		MAX. TORQUE		POWER/RPM		INPUT POWER CAPACITY				MAX. RPM		
	'A' Pos	'B' Pos	Nm	ftlb	kW	hp	1800 rpm		2100 rpm				
							kW	hp	kW	hp			
■	1.256	1.250	422	311	0.0442	0.0593	80	107	93	124	106	142	3200
■	1.514	1.521	422	311	0.0442	0.0593	80	107	93	124	106	142	3200
■	1.750*	1.770	422	311	0.0442	0.0593	80	107	93	124	106	142	3200
■	1.933	1.973	422	311	0.0442	0.0593	80	107	93	124	106	142	3200
■	2.480	2.476	414	305	0.0434	0.0581	78	105	91	122	104	140	3200
■	2.783	2.799	414	305	0.0434	0.0581	78	105	91	122	104	140	3200

\*'A' POS = continuous running position (normally AHEAD). 'B' POS = reverse position.

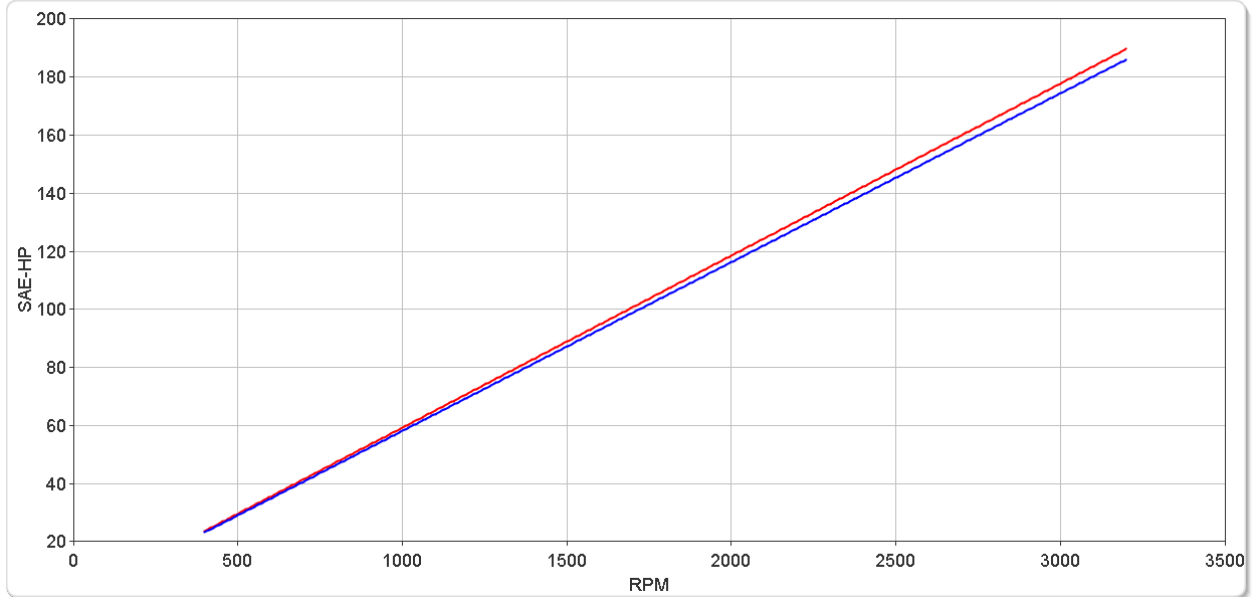
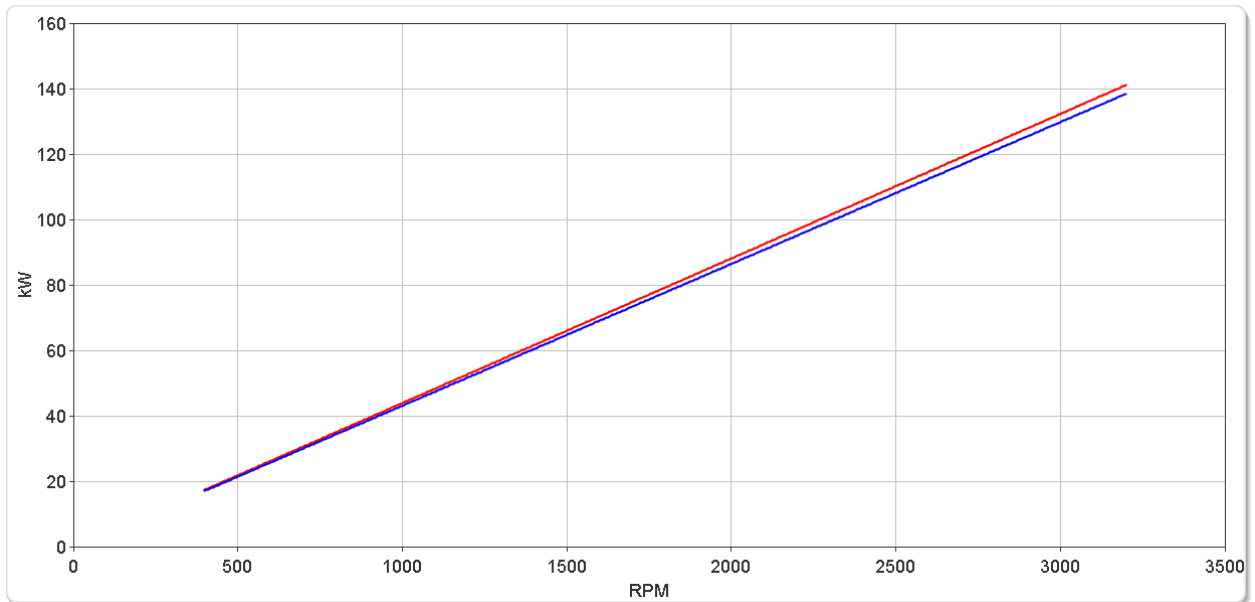

# ZF 63

## Dimensions

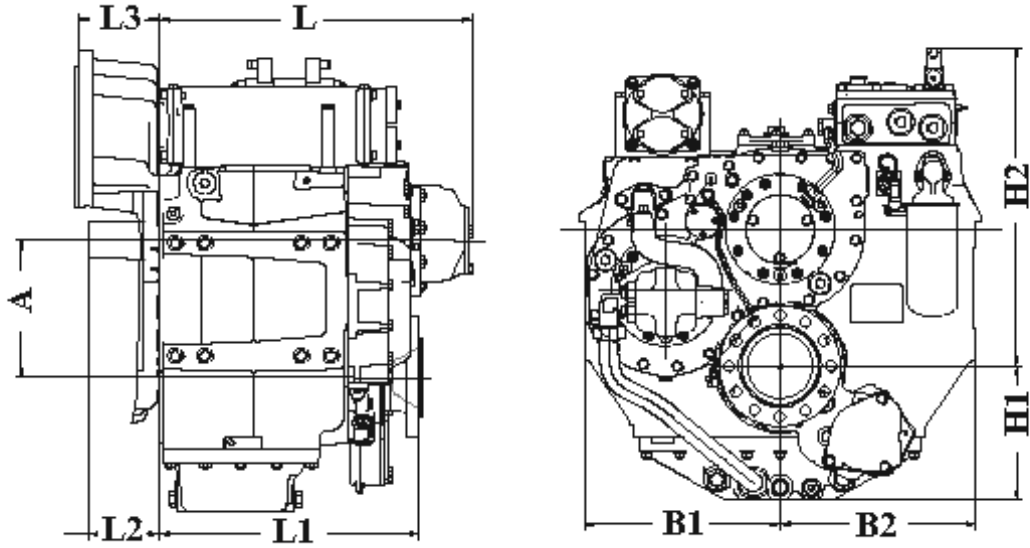

mm (inches)									
A	B <sub>1</sub>	B <sub>2</sub>	H <sub>1</sub>	H <sub>2</sub>	L	L <sub>1</sub>	L <sub>2</sub>	L <sub>3</sub>	Bell Hsg.
127 (4.98)	178 (6.99)	178 (6.99)	118 (4.67)	266 (10.5)	329 (13.0)	273 (10.8)	65.0 (2.56)	11.0 (0.43)	3
Weight kg (lb)					Oil Capacity Litre (US qt)				
46.0 ( 103)					3.80 (4.00)				

### SAE Bell Housing Dimensions

SAE No.	A		B		C		Bolt Holes		
	mm	in	mm	in	mm	in	No.	Diameter	
3	409.58	16.125	428.63	16.875	450.85	17.75	12	10.32	13/32
4	361.95	14.25	381.0	15.0	403.23	15.875	12	10.32	13/32
5	314.33	12.375	333.38	13.125	355.6	14.0	8	10.32	13/32

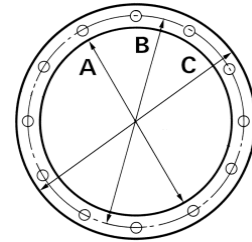

### Output Coupling Dimensions

A		B		C		D		Bolt Holes		
mm	in	mm	in	mm	in	mm	in	No.	Diameter (E)	
130	5.12	108	4.25	63.5	2.50	9.50	0.37	4	11.5	0.45

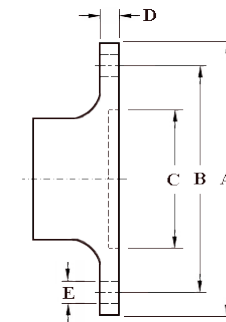

## Duty Definitions

<b>PLEASURE DUTY DEFINITION</b>	Highly intermittent operation with very large variations in engine speed and power
Average engine operating hours limit:	500 hours/year 300 hours/year for mechanical gearboxes
Typical hull forms:	Planing.
Typical applications:	Private, non-commercial, non-charter sport/leisure activities.
<b>LIGHT DUTY DEFINITION</b>	Intermittent operation with large variations in engine speed and power
Average engine operating hours limit:	2500 hours/year (for hydraulic gearboxes smaller than the ZF 650 series, 2000 hours/year).
Typical hull forms:	Planing and semi-displacement.
Typical applications:	Private and charter, sport/leisure activities, naval and police activities.
<b>MEDIUM DUTY DEFINITION</b>	Intermittent operation with some variations in engine speed and power
Average engine operating hours limit:	4000 hours/year. 3500 hours/year for gearboxes smaller than ZF 2000 series and workboat ZF W2700 series.
Typical hull forms:	Semi-displacement and displacement
Typical applications:	Charter and commercial craft (example: crew boats and fast ferries), and naval and police activities.
<b>CONTINUOUS DUTY DEFINITION</b>	Continuous operation with little or no variations in engine speed and power
Average engine operating hours limit:	Unlimited
Typical hull forms:	Displacement.
Typical applications:	Heavy duty commercial vessels, tugs, fishing boats.

## Duty Ratings

Ratings apply to marine diesel engines at the indicated speeds. At other engine speeds, the respective power capacity (kW) of the transmission can be obtained by multiplying the Power/Speed ratio by the speed.

Approximate conversion factors:

1 kW = 1.36 metric hp

1 kW = 1.34 U.S. hp (SAE)

1 U.S. hp = 1.014 metric hp

1 Nm = 0.74 lb.ft.

Ratings apply to right hand turning engines, i.e. engines having counterclockwise rotating flywheels when viewing the flywheel end of the engine.

These ratings allow full power through forward and reverse gear trains, unless otherwise stated.

Contact your nearest ZF Sales and Service office for ratings applicable to gas turbines, gasoline (petrol) engines, as well as left hand turning engines, and marine transmissions for large horsepower capacity engines.

Ratings apply to marine transmissions currently in production or in development and are subject to change without prior notice.

**NOTE:** THE MAXIMUM RATED INPUT POWER MUST NOT BE EXCEEDED (SEE RESPECTIVE RATINGS IN THE TECHNICAL DATA SHEETS)

## Safe Operating Notice

The safe operation of ZF products depends upon adherence to technical data presented in our brochures. Safe operation also depends upon proper installation, operation and routine maintenance and inspection under prevailing conditions and recommendations set forth by ZF. Damage to transmission caused by repeated or continuous emergency manoeuvres or abnormal operation is not covered under warranty. It is the responsibility of users and not ZF to provide and install guards and safety devices, which may be required by recognized safety standards of the respective country (e.g. for U.S.A. the Occupational Safety Act of 1970 and its subsequent provisions).

## Monitoring Notice

The safe operation of ZF products depends upon adherence to ZF monitoring recommendations presented in our operating manuals, etc. It is the responsibility of users and not ZF to provide and install monitoring devices and safety interlock systems as may be deemed prudent by ZF. Consult ZF for details and recommendations.

## Torsional Responsibility and Torsional Couplings

The responsibility for ensuring torsional compatibility rests with the assembler of the drive and driven equipment. ZF can accept no liability for gearbox noise caused by vibrations or for damage to the gearbox, the flexible coupling or to other parts of the drive unit caused by this kind of vibration. Contact ZF for further information and assistance. ZF recommends the use of a torsional limit stop for single engine powered boats, wherein loss of propulsion power can result in loss of control. It is the buyer's responsibility to specify this option, which can result in additional cost and a possible increase in installation length.

ZF can accept no liability for personal injury, loss of life, or damage or loss of property due to the failure of the buyer to specify a torsional limit stop. ZF selects torsional couplings on the basis of nominal input torque ratings and commonly accepted rated engine governed speeds. Consult ZF for details concerning speed limits of standard offering torsional couplings, which can be less than the transmission limit. Special torsional couplings may be required for Survey Society Ice Classification requirements.

