

SX-M1 2.18, SX-M1 1.97, SX-M1 1.89, SX-M1 1.79

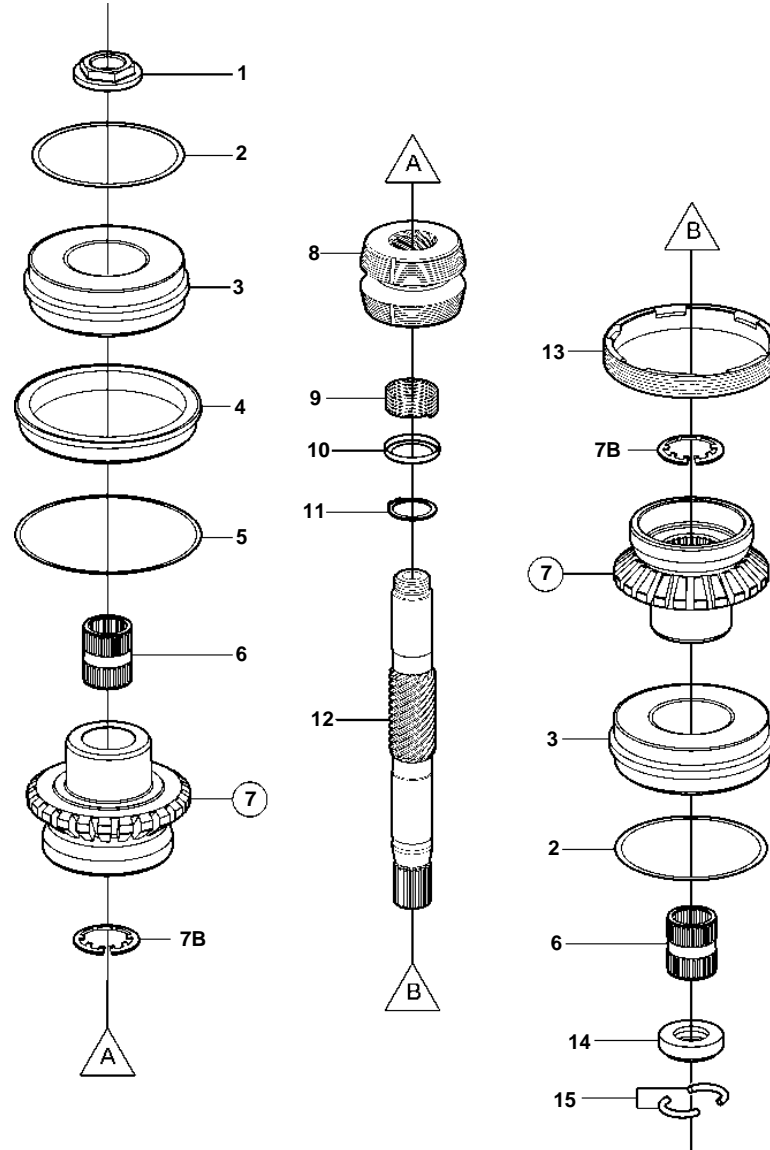

SX-M1 2.18, SX-M1 1.97, SX-M1 1.89, SX-M1 1.79

REF	PART NO.	QTY	DESCRIPTION	NOTES
1	3852301	X	Nut	TH = 0.00
	3852302	X	Nut	TH = 0.20mm
	3852303	X	Nut	TH = 0.40mm
	3852375	X	Nut	TH = 0.60mm
2	3852368	X	Shim	TH=0.002"
	3852369	X	Shim	TH=0.003"
	3852370	X	Shim	TH=0.004"
	3852371	X	Shim	TH=0.005"
	3852372	X	Shim	TH=0.010"
3	3857176	2	Bearing kit	
4	3852269	1	Support ring	
5	3852363	X	Shim	TH=0.002"
	3852364	X	Shim	TH=0.003"
	3852365	X	Shim	TH=0.004"
	3852366	X	Shim	TH=0.005"
	3852367	X	Shim	TH=0.010"
6	3852390	2	Needle bearing	
7	3856996	1	Gear set	
7B	190356	2	Retaining ring	
8	3855783	1	Sliding sleeve	
9	3852296	1	Spring	
10	3852298	1	Washer	
11	951078	1	Snap ring	
12	3852292	1	Shaft	
13	3852262	1	Retainer	
14	3852294	1	Ring	
15	3852295	2	Lock clip	