

MS25S-A, MS25SR-A

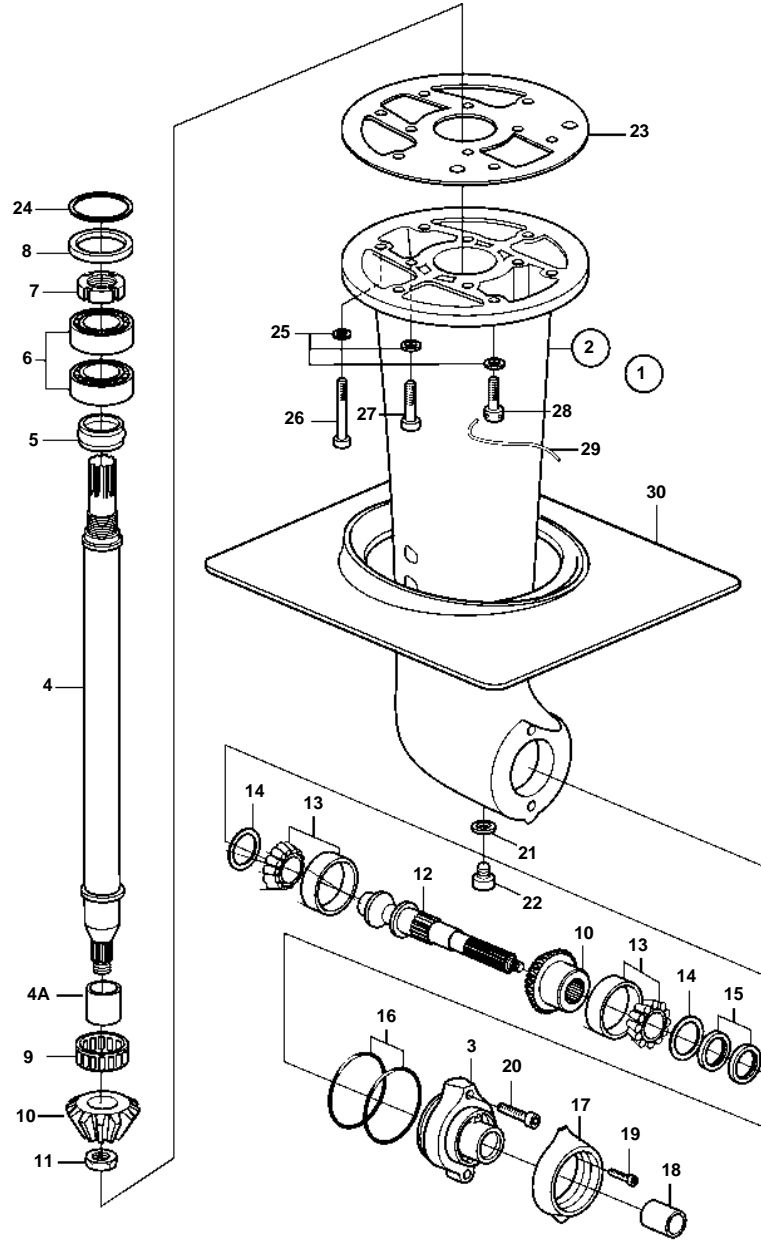

18297

MS25S-A, MS25SR-A

REF	PART NO.	QTY	DESCRIPTION	NOTES
1	3583353	1	Gear under	
2		1	· Gear housing	
3	873127	1	· · Bearing housing	(3583364)
4	3582881	1	· Shaft	
4A		1	· · Sleeve	
5	3582883	1	· Bushing	
6	3583326	2	· Bearing	
7	3582869	1	· Nut	
8		1	· Spacer	
9	3582868	1	· Bearing	
10	3583362	1	· Gear set	
11	3582885	1	· Nut	
12	3582888	1	· Shaft	
13	3582473	2	· Bearing race	
14	3582477	X	· Shim	TH = 0,10mm
	3582478	X	· Shim	TH = 0.15mm
	3582876	X	· Shim	TH=0,20mm
	3582479	X	· Shim	TH = 0,30mm
	3583347	X	· Shim	TH = 0,50mm
15	3582889	2	· Ring	
16	925256	2	· O-ring	
17	876286	1	· Zinc ring kit	
18	3582887	1	· Spacer	
19	949823	2	· Screw	M6
20	946541	2	· Screw	M8
21	852904	1	· Magnetic plug	(839354)
22		1	· Plug	
23	3582893	1	Gasket	Included in kit 877362.
24	3582566	X	Shim	TH = 0,10mm
	3582567	X	Shim	TH = 0.15mm
	3582903	X	Shim	TH=0,20mm
	3582568	X	Shim	TH = 0,30mm
	3582569	X	Shim	TH = 0,50mm
25	941670	10	Washer	
26	963703	2	Screw	
27	963699	4	Screw	
28	3582895	4	Lock screw	
29	3582896	X	Locking wire	L=700mm. Included in kit 877362.
30	3583365	1	Mounting kit	