

MS15A-A, MS15A-B

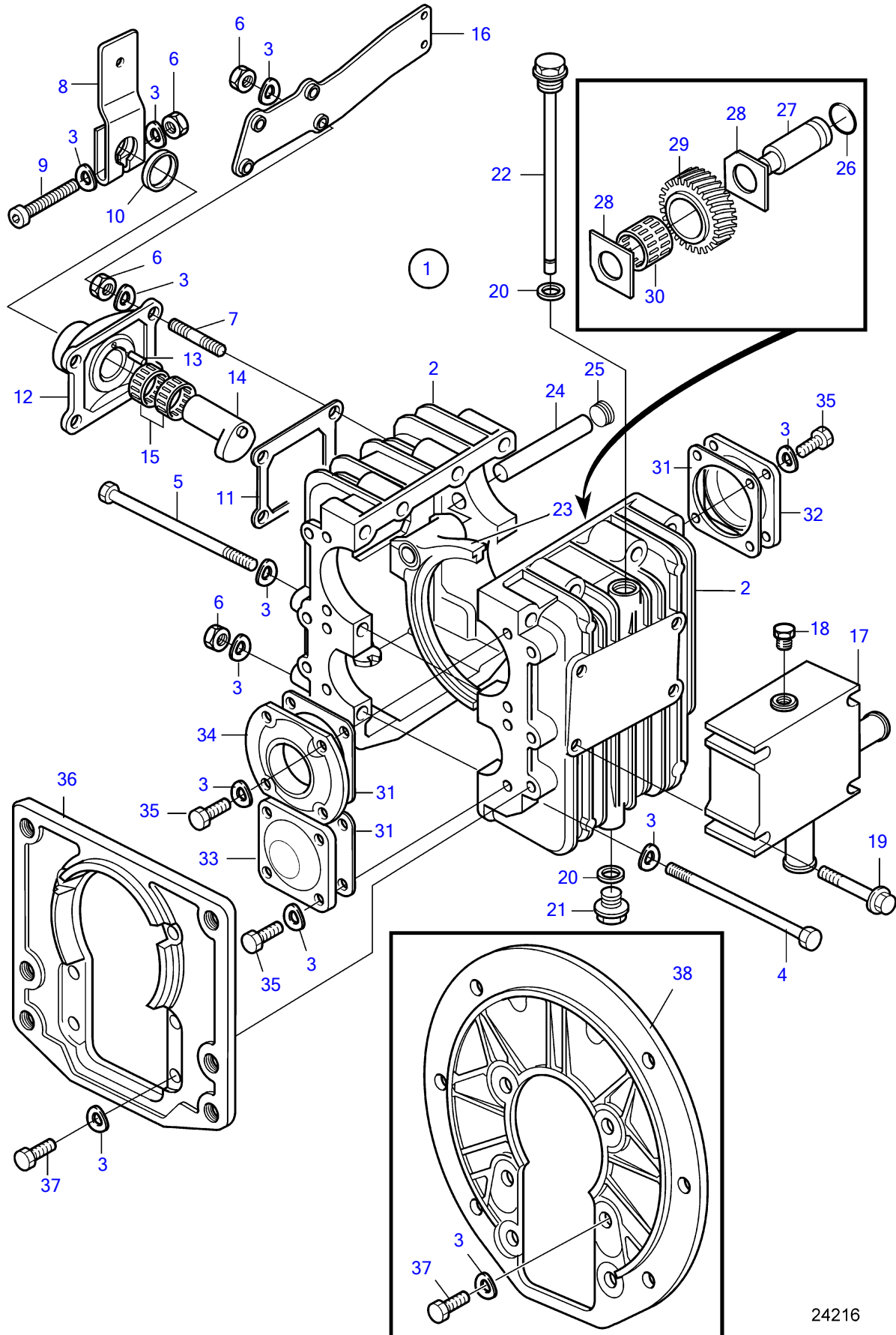

24216

MS15A-A, MS15A-B

REF	PART NO.	QTY	DESCRIPTION	NOTES
1	3582391	1	Reversing gear	MS15A-A, ratio 2.14:1
	3809124	1	Reversing gear kit	MS15A-B, ratio 2.14:1
2		1	• Housing	
3	941907	36	• Spring washer	
4	940129	9	• Hexagon screw	
5	940129	1	• Hexagon screw	
6	955782	10	• Hexagon nut	
7	980289	4	• Stud	
8	3586320	1	• Engagement lever	(3581965)
9	955298	1	• Hexagon screw	
10	3581966	1	• Sealing	
11	3581982	1	• Gasket	
12	3581967	1	• Cardboard tube	
13		1	• Locating pin	
14	3581969	1	• Cam	
15	3582009	2	• Bearing	
16	3586718	1	• Bracket	(3582614)
17	3582641	1	• Oil cooler	
18	479956	1	• Plug	
19	965180	4	• Flange screw	
20	957179	2	• Gasket	
21	3582174	1	• Plug	
22	3582534	1	• Dipstick	
23	3582462	1	• Fork	
24	3582463	1	• Fork shaft	
25	3581973	1	• Plug	
26	3582610	1	• O-ring	
27	3582465	1	• Shaft	
28	3582466	2	• Plate	
29	3582467	1	• Gear	
30	3582468	1	• Needle bearing	
31	3582469	3	• Gasket	
32		1	• Cover	
33		1	• Cover	
34		1	• Cover	
35	955294	18	• Hexagon screw	
36	3582615	1	• Plate	
37	955294	6	• Hexagon screw	
38	3819841	1	Adapter	For MS15A-B