

IPS2-A

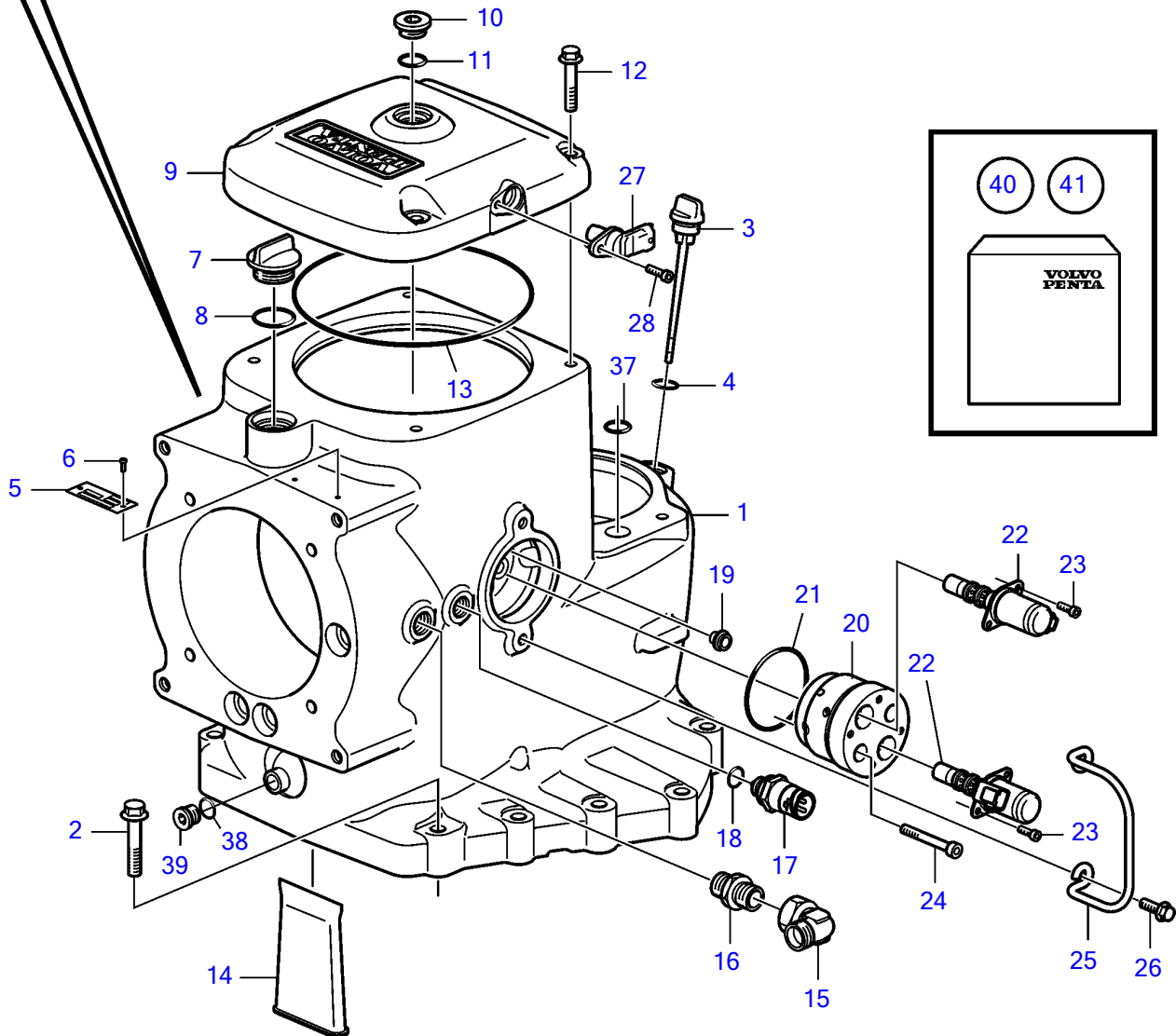
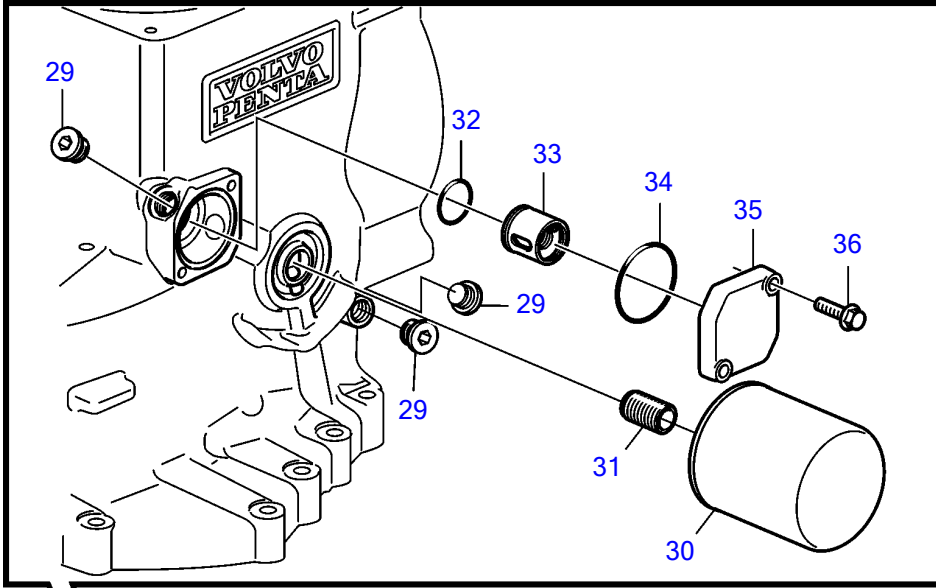

IPS2-A

REF	PART NO.	QTY	DESCRIPTION	SEE SEC.	NOTES
1	3801239	1	Upper gear		
2	991609	10	Flange screw		
3	21697751	1	Dipstick		
4	949656	1	O-ring		
5	3817315	1	Type plate		
6	804269	2	Drive screw		
7	840559	1	Cover		
8	949659	1	O-ring		
9	3842939	1	Cover		
10	3889952	1	Plug		
11	949656	1	O-ring		
12	991607	4	Flange screw		
13	993307	1	O-ring		
14	3849894	1	Oil strainer		
15	992197	1	Elbow nipple		
16	992036	1	Nipple		
17	874313	1	Sensor, oil pressure/temperature		
18	968559	1	O-ring		
19	422413	6	Sealing ring		
20	21260636	1	Valve housing		
21	925094	1	O-ring		
22	11418522	2	Valve		
23	963677	4	Hex. socket screw		
24	963703	2	Hex. socket screw		
25	3861876	1	Protecting brace		
26	991606	2	Flange screw		
27	21123875	1	Sensor		
28	963684	1	Hex. socket screw		
29	992119	3	Plug		
30	471034	1	Oil filter		
			• Bulletin P-18-3-11	P-18-3-11-EN	QUANT PAC of Maintenance parts
31	423067	1	Nipple		
32	949659	1	O-ring		
33	3847325	1	Valve housing, complete		
34	967343	1	O-ring		
35	(3885069)	1	Cardboard tube		Obsolete part
36	992246	2	Flange screw		M10x30
37	949657	1	O-ring		
38	976039	1	O-ring		
39	992119	1	Plug		
40	22349391	1	Hose		
41	22349393	1	Air vent hose		