

TD71AG,TD71AGP,TID71AG,TID71AGP

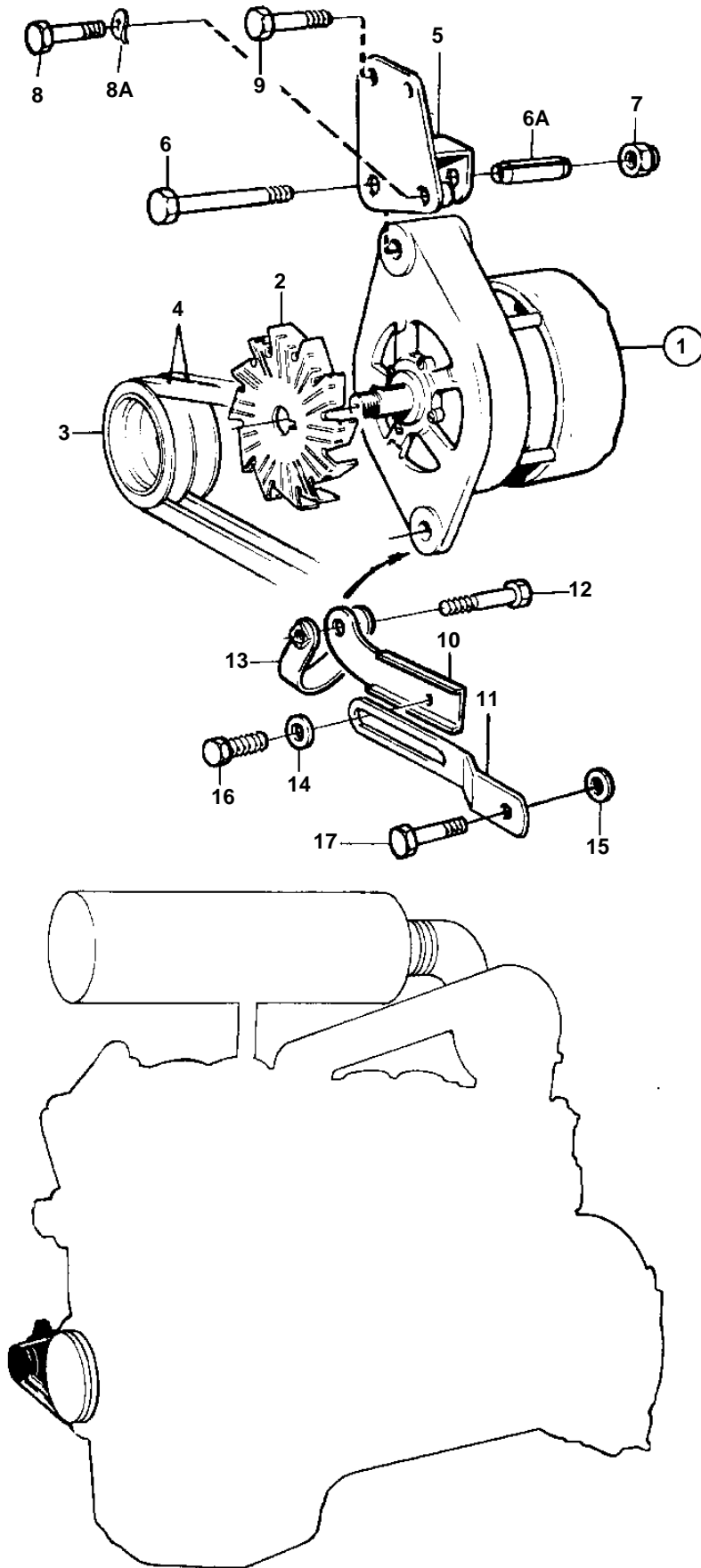

10473

TD71AG,TD71AGP,TID71AG,TID71AGP

REF	PART NO.	QTY	DESCRIPTION	SEE SEC.	NOTES
1	858838	1	Alternator		14V 50A. FOR 12 VOLTAGE ELECTRIC SYSTEM.
				030-1000	
	872018	1	Alternator		14V 50A. FOR 12 VOLTAGE ELECTRIC SYSTEM.
				030-0940	
	872926	1	Alternator		14V 50A. FOR 12 VOLTAGE ELECTRIC SYSTEM.
				030-0940	
	845940	1	Alternator		24V 55A. FOR 24 VOLTAGE ELECTRIC SYSTEM.
				030-0900	
	849563	1	Alternator		28V 55A. FOR 24 VOLTAGE ELECTRIC SYSTEM.
				030-0900	
	863955	1	Alternator		28V 60A. FOR 24 VOLTAGE ELECTRIC SYSTEM.. ALSO AVAILABLE AS AN EXCHANGE PART.
			Bulletin 45-02A	45-02A-EN	Alternator
1				030-0925	
	872021	1	Alternator		28V 60A. FOR 24 VOLTAGE ELECTRIC SYSTEM.
				030-0950	
2	847707	1	• Fan		FOR 24 VOLTAGE ELECTRIC SYSTEM.
	840621	1	• Fan		FOR 12 VOLTAGE ELECTRIC SYSTEM.
3	822573	1	Pulley		
4	966986	1	V-belt set		L = 2X1250 MM
	966988	1	V-belt set		L = 2X1275 MM,526)
5	849354	1	Bracket		
	863182	1			FOR ENGINE WITH FLEXIBLE ENGINE MOUNTS.
6	955555	1	Screw		
6A	1610144	1	Pin		FÖR/FOR 872021
7	950355	1	Nut		
8	970954	1	Screw		L = 60 MM
8A	941908	1	Spring washer		
9	946470	1	Flange screw		L = 35 MM
	965180	1	Flange screw		L = 60 MM
10	847956	1	Tensioner		
11	849295	1	Tensioner		
12	947760	1	Flange screw		
13	466734	1	Tensioning eyelet		
14	191172	1	Washer		
15	960141	2	Washer		
16	946173	1	Flange screw		
17	965183	1	Flange screw		