

TD1010G, TWD1010G

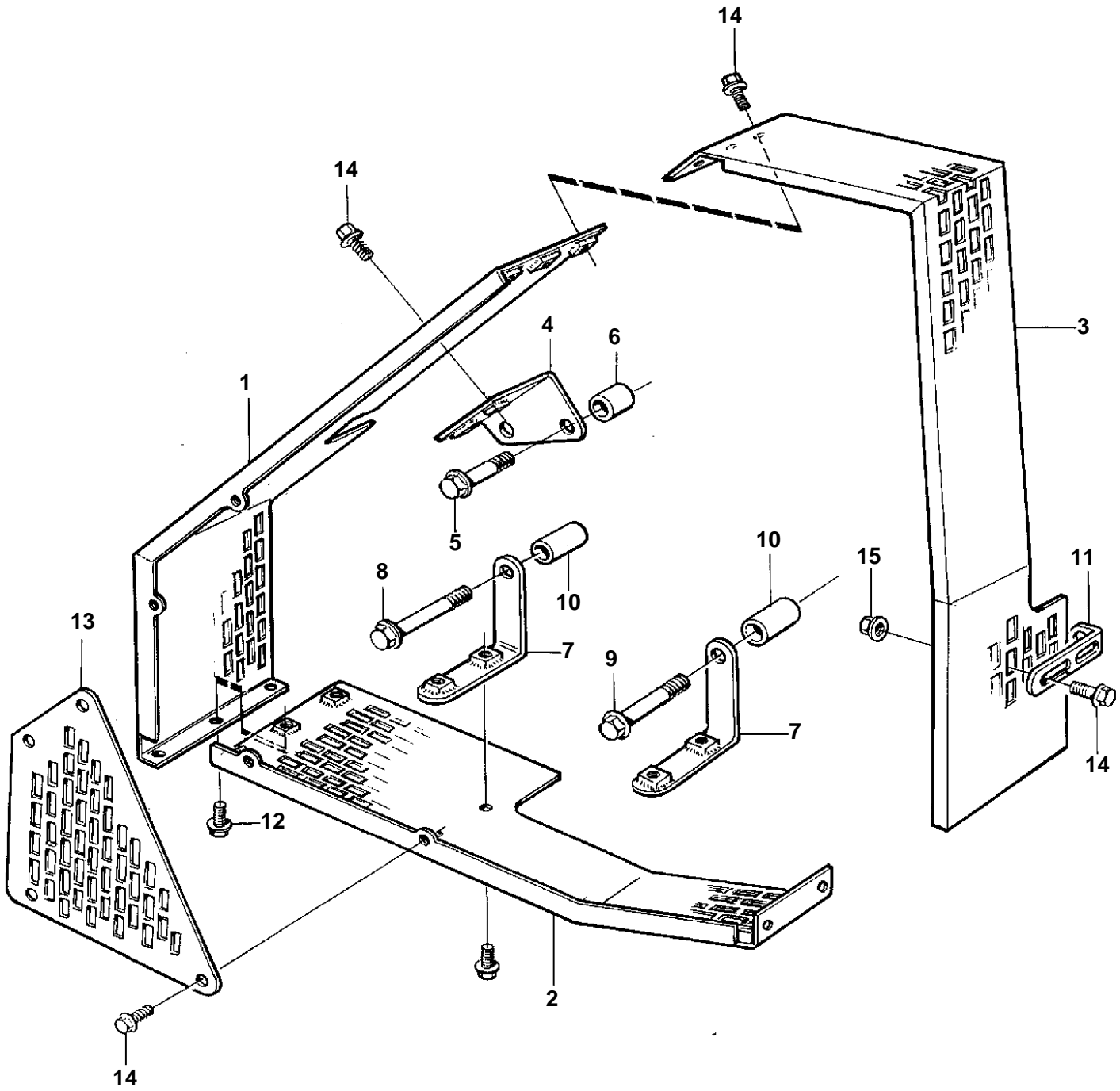

16711

TD1010G, TWD1010G

REF	PART NO.	QTY	DESCRIPTION	NOTES
1	3826258	1	Belt protector	
2	3826616	1	Belt protector	
3	3826617	1	Belt protector	
4	3825673	1	Bracket	
5	955538	2	Screw	
6	827861	2	Spacer sleeve	
7	3825677	2	Bracket	
8	942529	1	Screw	L=108mm
9	955543	1	Screw	L=95mm
10	829653	2	Spacer sleeve	
11	965562	1	Bracket	
12	955534	2	Screw	
13	3825676	1	Protecting plate	
14	967949	19	Screw	
15	945407	2	Flange nut	