

TMD41A, TMD41B, D41A, D41B, TAMD41A, TAMD41B, AQAD41A, AD41A, AD41B

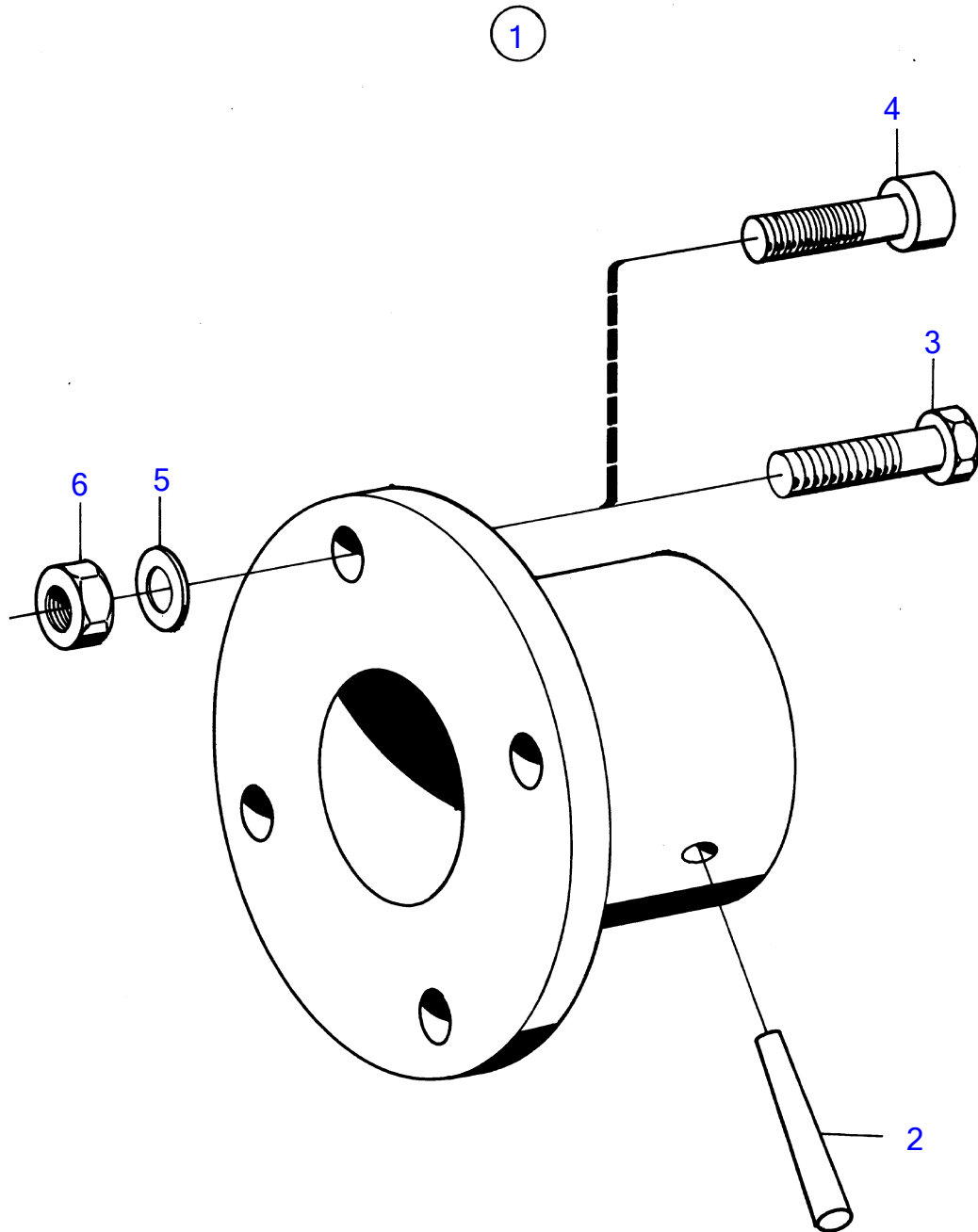

3232

TMD41A, TMD41B, D41A, D41B, TAMD41A, TAMD41B, AQAD41A, AD41A, AD41B

REF	PART NO.	QTY	DESCRIPTION	NOTES
1	806383	1	Clutch flange	Center drilled., D=30mm
2	907599	1	• Taper pin	
3	955319	4	• Hexagon screw	
4	959239	4	• Hex. socket screw	
5	941908	4	• Spring washer	
6	955783	4	• Hexagon nut	