

TMD122A, TAMD122A

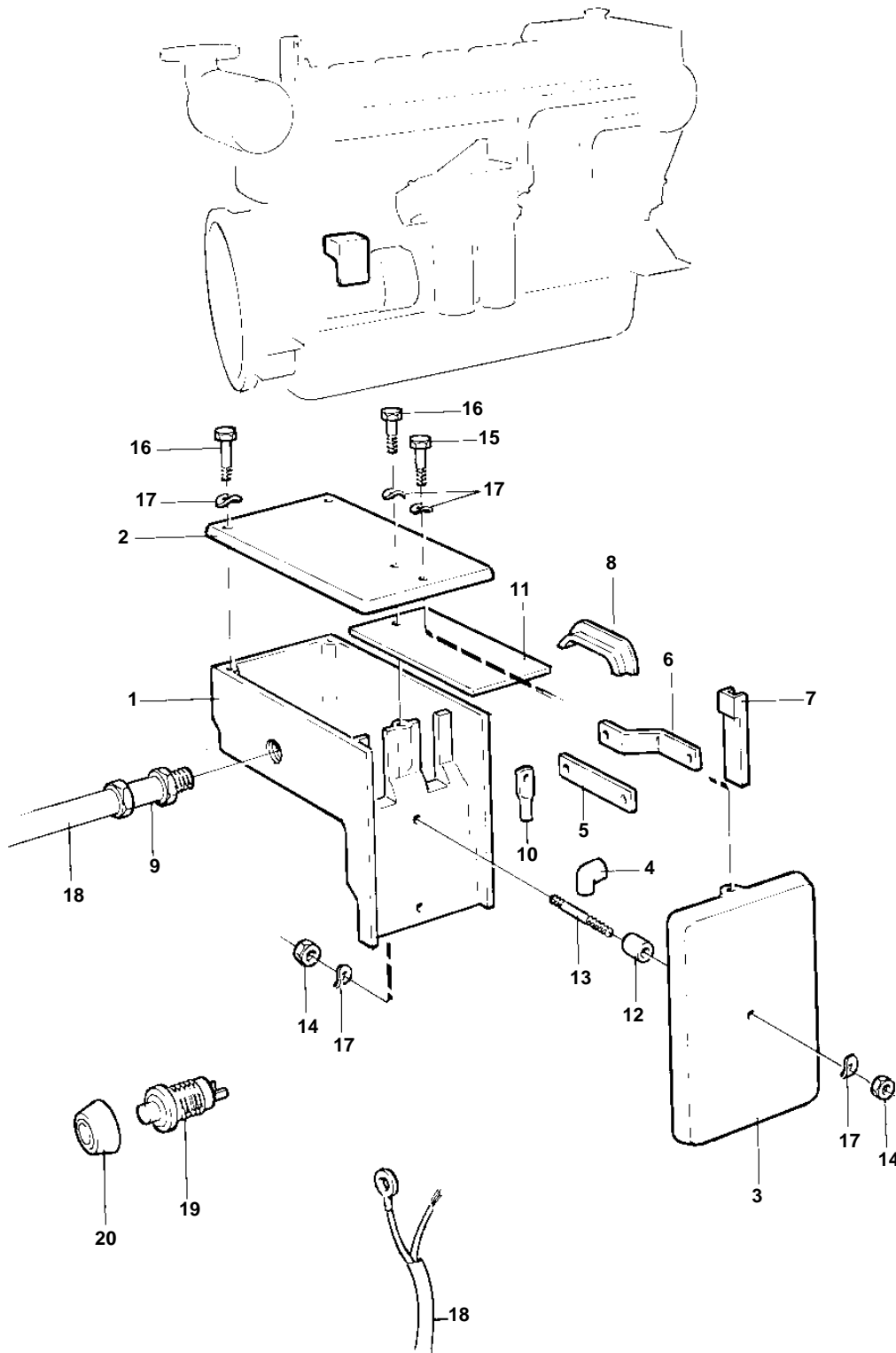

6514

TMD122A, TAMD122A

REF	PART NO.	QTY	DESCRIPTION	SEE SEC.	NOTES
1	846565	1	Electrical distribut		
2	837378	1	Cover		
3	837379	1	Cover		
4	847742	2	Clamping sleeve		
5	837483	1	Guide rail		
6	837484	1	Guide rail		
7	837486	4	Housing		
8	837488	1	Sealing strip		
9	881192	2	Cable union		
10		X	Electrical materials	1963	
11	837558	1	Rubber guard		
12	192618	X	Hose		L=50mm
13	946945	1	Stud		
14	955825	2	Nut		
15	955513	1	Screw		
16	940117	3	Screw		
17	941906	7	Spring washer		
18		X	Electrical materials	1963	
19	843684	1	Button		
20	837533	1	Rubber cap		