

TAMD71A

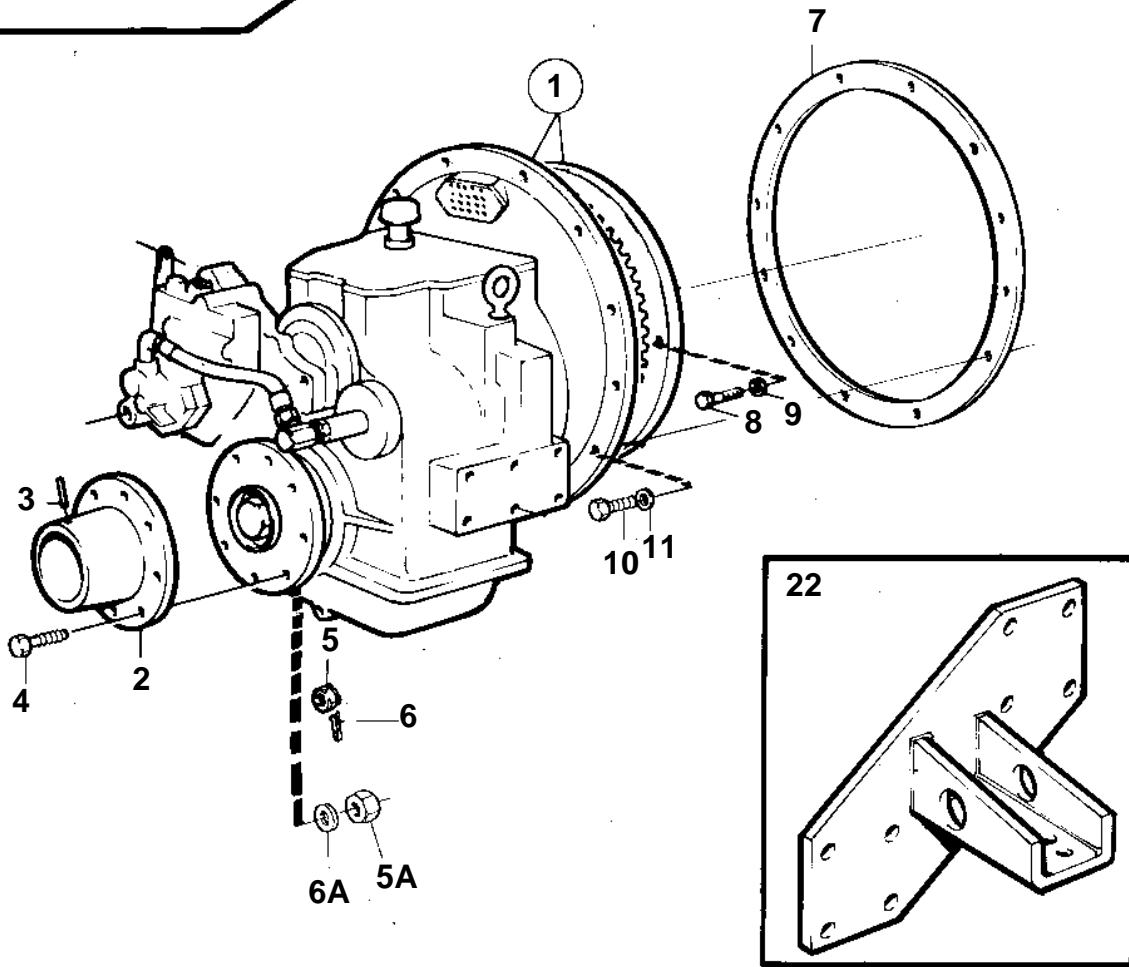
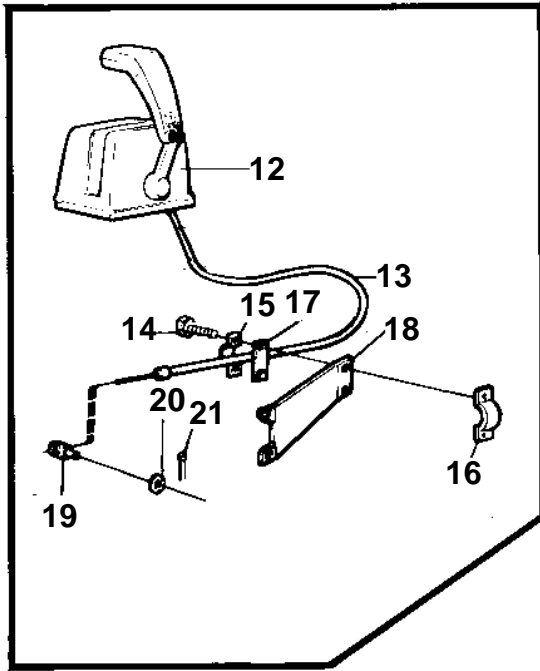

## TAMD71A

REF	PART NO.	QTY	DESCRIPTION		NOTES
1		1	Reversing gear Comps. not spec.		RATIO -4.50:1. For reverse gear MG509, RATIO 3.81-, use flywheel 848350.
2	837093	1	Companion flange	SO	For reverse gear RATIO 3.80:1-
	837055	1	Clutch flange		For reverse gear RATIO -3.00:1
3		2	Pin		For reverse gear RATIO 3.80:1-
	965011	2	Pin	SO	For reverse gear RATIO -3.00:1
4	955773	8	Screw		For reverse gear RATIO 3.80:1-
		6	Screw		For reverse gear RATIO -3.00:1
5	955889	8	Castle nut		For reverse gear RATIO 3.80:1-
	955887	6	Nut		For reverse gear RATIO -3.00:1
6	907881	8	Cotter pin		For reverse gear RATIO 3.80:1-
	907861	6	Cotter pin		For reverse gear RATIO -3.00:1
7	862623	1	Gasket		
8	940162	8	Screw		
9	942336	8	Spring washer		
10	955535	12	Screw		
11	942336	12	Spring washer		
12		X	Control		SEE GROUP 27
13		X	Control cable		SEE GROUP 27
14	950021	2	Screw		
15	819067	1	Brace		For control cable 333, 33c.
16	6853782	1	Clamp		For control cable 443, 43c.
17	819068	1	Washer		
18	836117	1	Bracket		
19	853217	1	Cube		
20	940191	1	Washer		
21	907824	1	Cotter pin		
22		2	Engine suspension		SEE GROUP 21