

TAMD71A

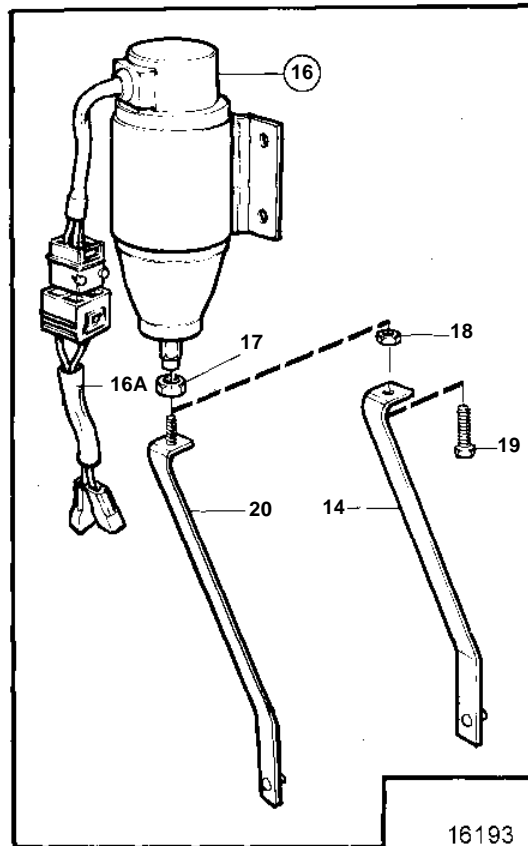
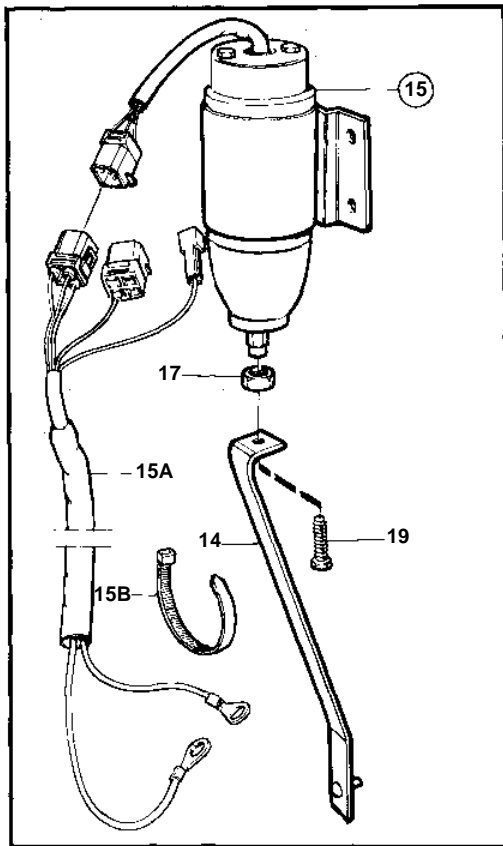
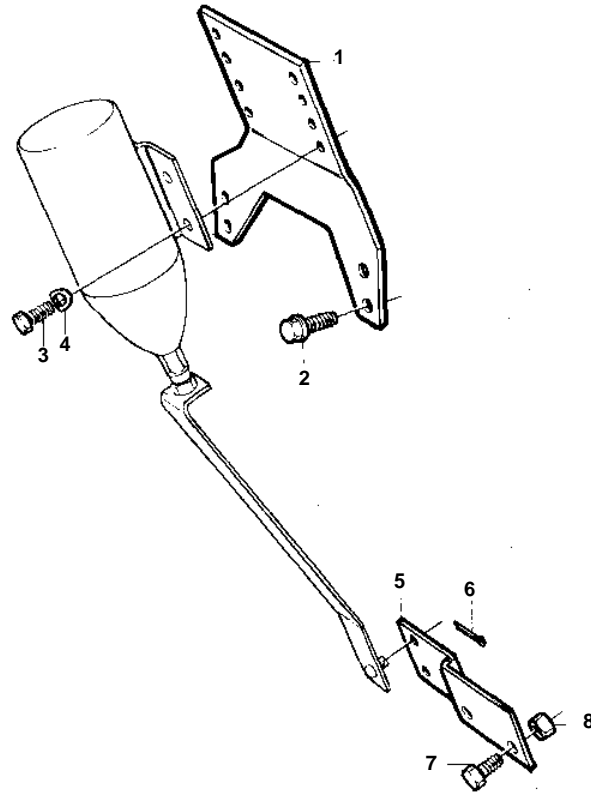
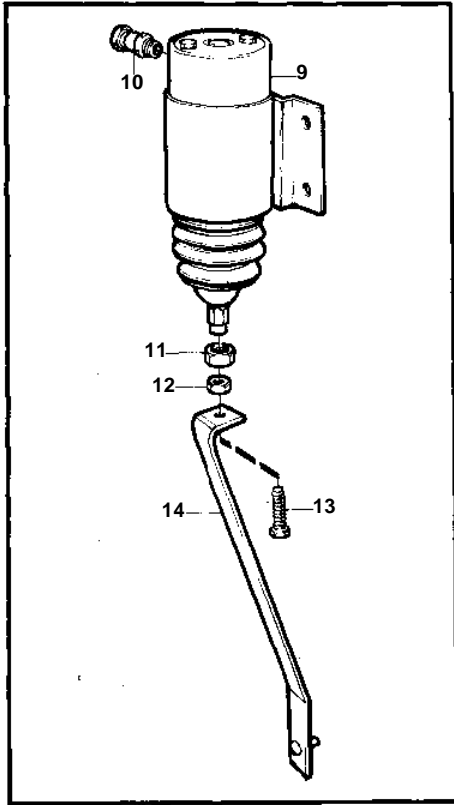

16193

TAMD71A

REF	PART NO.	QTY	DESCRIPTION	NOTES
1	848105	1	Bracket	
2	946440	2	Flange screw	
3	955269	4	Screw	
4	949607	4	Spring washer	
5	848811	1	Lever	
6	664822	1	Lock spring	
7	945414	2	Screw	
8	946035	2	Lock nut	
9	872826	1	Stop solenoid	12V, LATE TYPE
	872825	1	Stop solenoid	24V, LATE TYPE
10	881191	1	Cable union	
11	955857	1	Nut	5/16
12	921781	1	Nut	5/16
13	955658	1	Screw	5/16
14	848782	1	Link arm	
15	876788	1	Control magnet kit	12V, LATE TYPE
	876789	1	Control magnet kit	24V, LATE TYPE
15A	873638	1	Cable kit	LATE TYPE
15B	948211	1	Strip clamp	
16	876592	1	Control magnet kit	12V, EARLY TYPE
	876593	1	Control magnet kit	24V, EARLY TYPE
16A		1	Adapter	EARLY TYPE
17	955782	1	Nut	M8 (947941)
18	955782	1	Nut	M8
19	955297	1	Screw	M8
20		1	Link arm	Replaced by 1 ea linkarm 848782, 1 ea screw 955297 and 1 ea nut 955782.