

TAMD61A

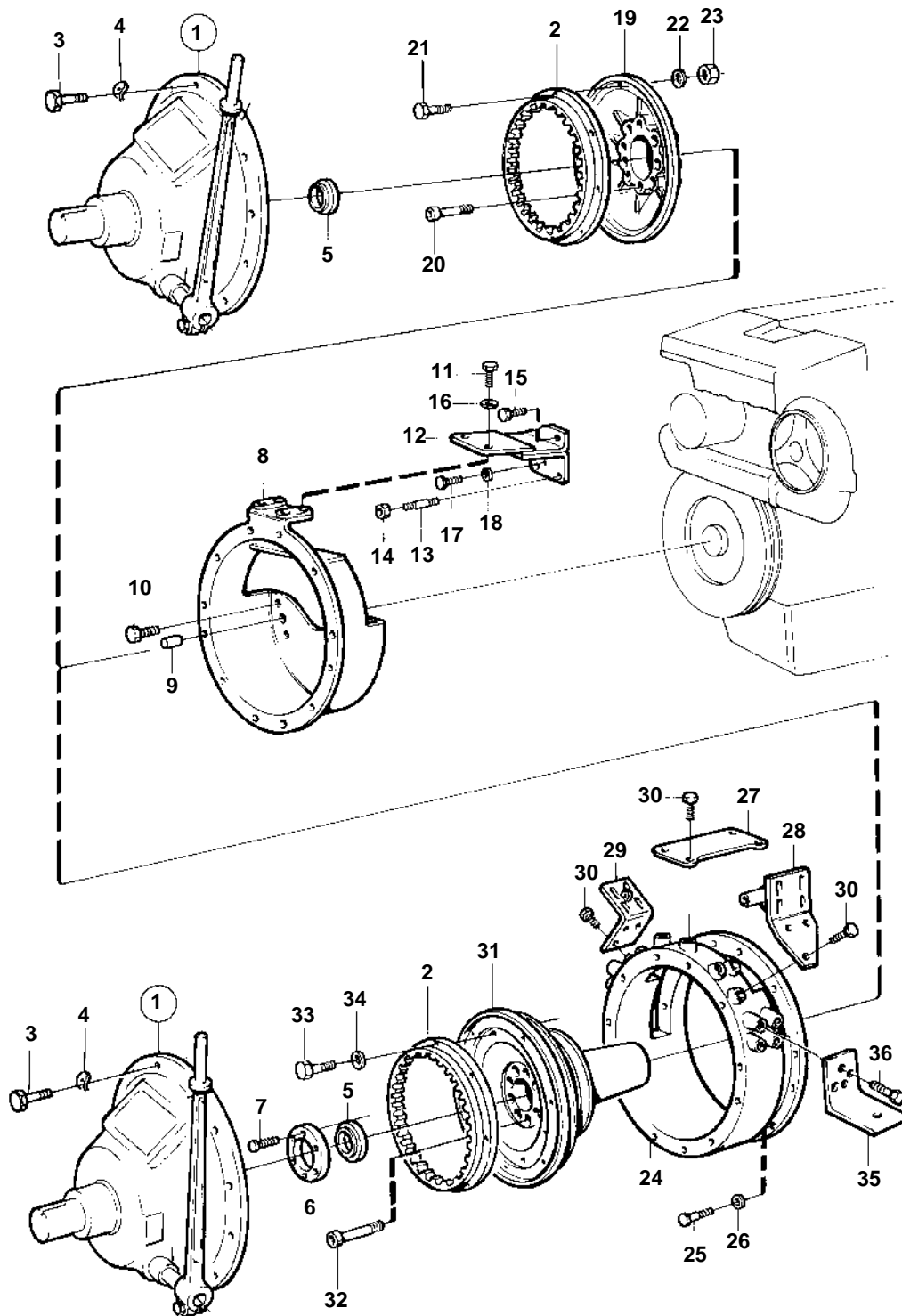

15397

TAMD61A

REF	PART NO.	QTY	DESCRIPTION	SEE SEC.	NOTES
1		1	Clutch		REPLACED BY 849716
				855	
		1	Clutch		
				855	
2	814879	1	Gear ring	855	
3	959238	12	Screw		
4	941908	12	Spring washer		
5	183455	1	Ball bearing		
6		1	Bearing seat		
7	946671	4	Flange screw		
8	849359	1	Bell housing	SO	
9	191171	2	Pin		
10	965183	4	Flange screw		
11	973083	2	Flange screw		
12	849368	1	Bracket	SO	
13	924075	2	Stud		
14	971095	2	Nut		
15	970960	1	Screw	SO	FOR MG5061,5061A
16	941908	2	Spring washer		
17	955302	1	Screw		L=60mm
18	941907	1	Spring washer		
19	844698	1	Companion flange		
20	465828	8	Screw		
21	940162	6	Screw		
22	942336	6	Spring washer		
23	955827	6	Nut		
24	849360	1	Cover	SO	
25	959238	12	Screw		
26	941908	12	Spring washer		
27	849369	1	Bracket	SO	
28	849377	1	Bracket	SO	
29	849378	1	Bracket		
30	973083	10	Flange screw		
31	862710	1	Companion flange		
32	471481	8	Screw		
33	955535	6	Screw		
34	942336	6	Spring washer		
35	837464	2	Bracket		
36	965191	4	Screw		