

DPX

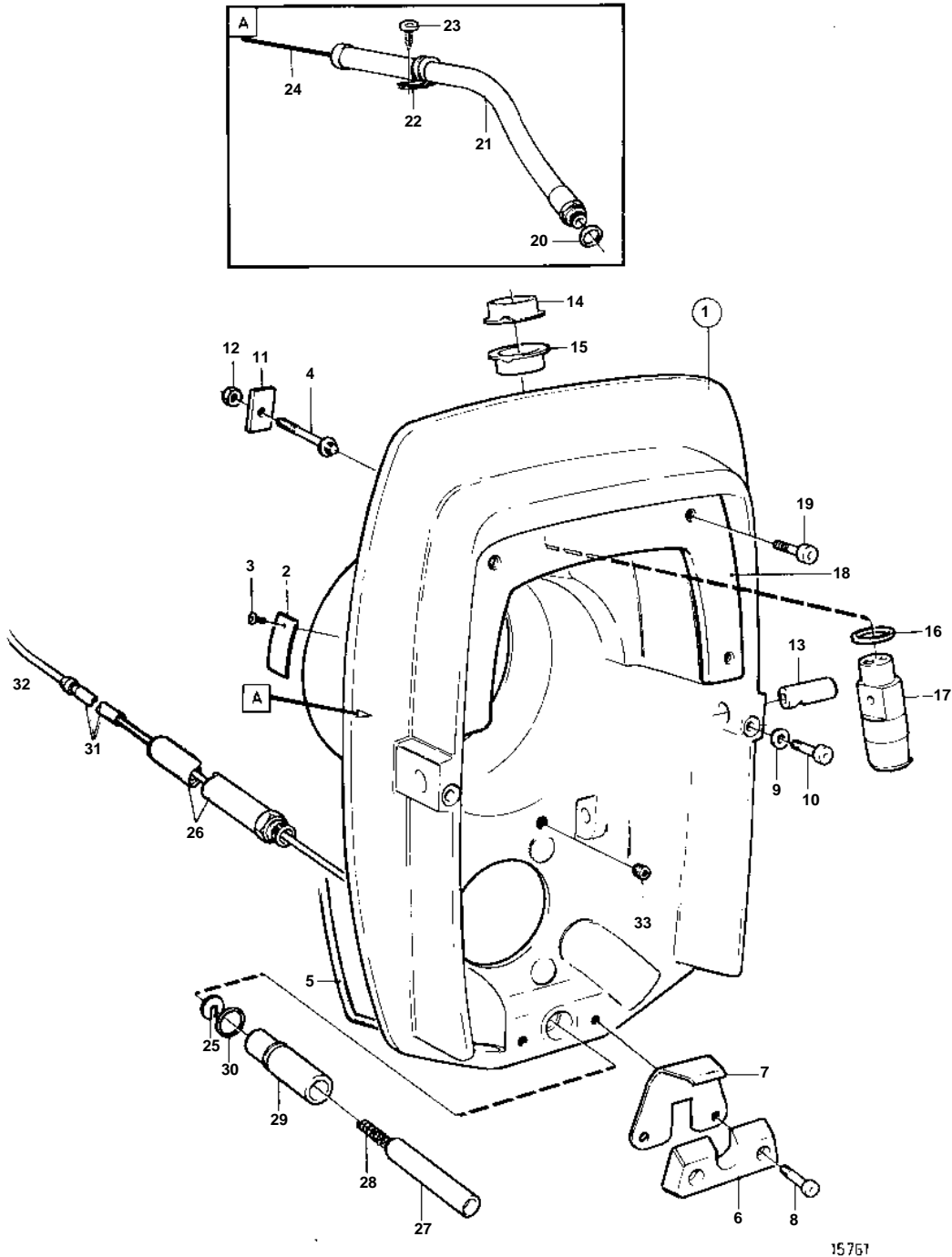

DPX

REF	PART NO.	QTY	DESCRIPTION	SEE SEC.	NOTES
1	876630	1	Shield		
2	853706	1	• Type plate		
3	804269	2	• Rivet		
4	873316	6	Stud		
5	852868	X	Sealing strip		L=1750mm
6	872139	1	Zinc anod		
7	872963	2	Support plate		
8	946541	2	Screw		
9	941670	2	Washer		
10	963699	2	Screw		
11	852866	6	Washer		
12	963108	6	Nut		
13	872493	2	Pin		
14	854705	1	Bushing		
15	854704	1	Bushing		
16	977313	1	Sealing ring		
17	872956	1	Grommet		
18	872971	1	Protection		
19	963683	4	Screw		
20	897745	1	Gasket		
21	839091	1	Hose		
22	952635	1	Clamp		
23	955512	1	Screw		
24		X	Control cable	231	
25	872962	1	Washer		
26	872669	1	Protecting hose		
27	872667	1	Piston		
28	872668	1	Spring		
29	873246	1	Pipe		
30	979668	1	• O-ring		
31	961662	1	Clamp		
32		X	Control cable	231	
33	853215	2	Plug		