

TAMD103A-A, TAMD103A-A AUX

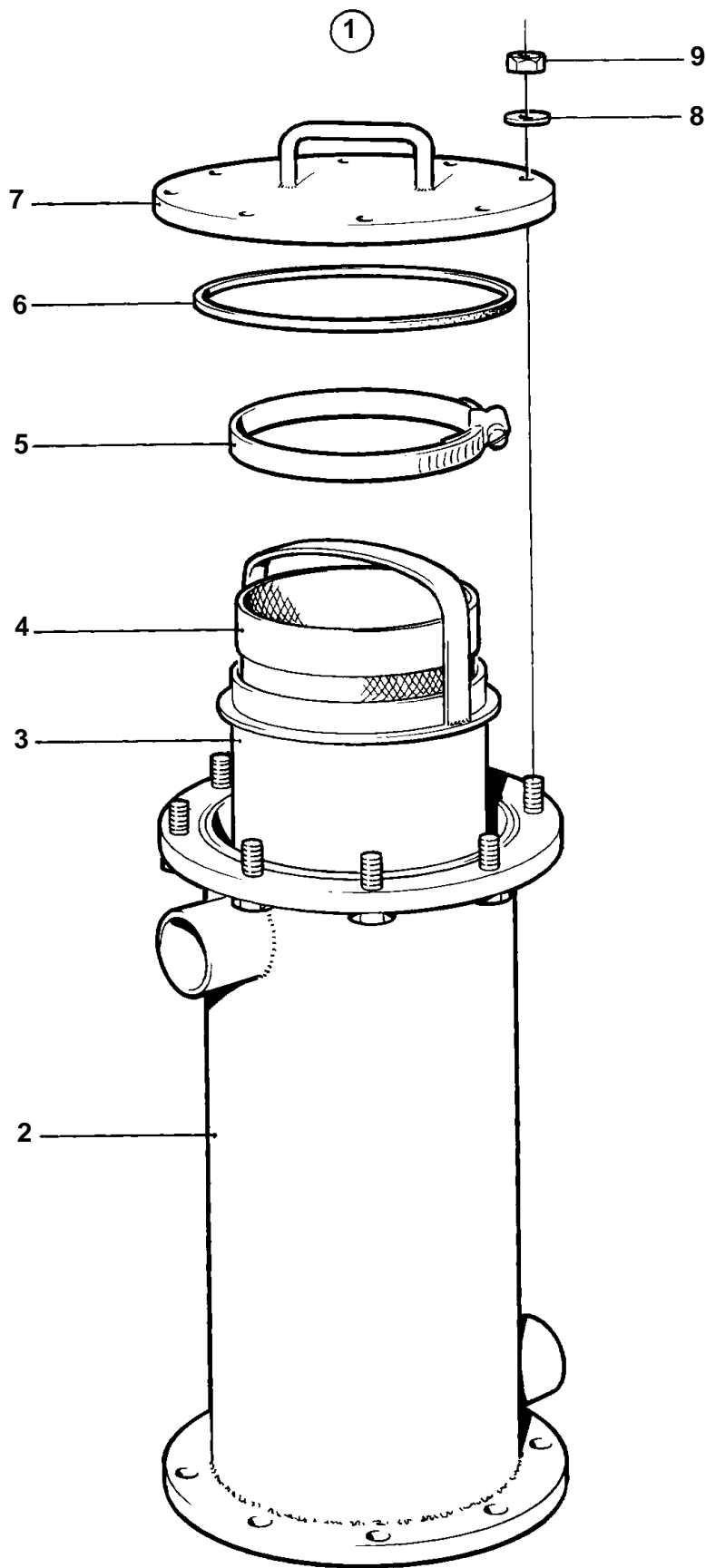

5552

