

D3-110I-D, D3-110I-E, D3-110I-F, D3-140I-E, D3-140I-F, D3-150I-D, D3-150I-E, D3-150I-F, D3-170I-D, D3-170I-E, D3-170I-F, D3-200I-D, D3-200I-E, D3-200I-F, D3-220I-D, D3-220I-E, D3-220I-F

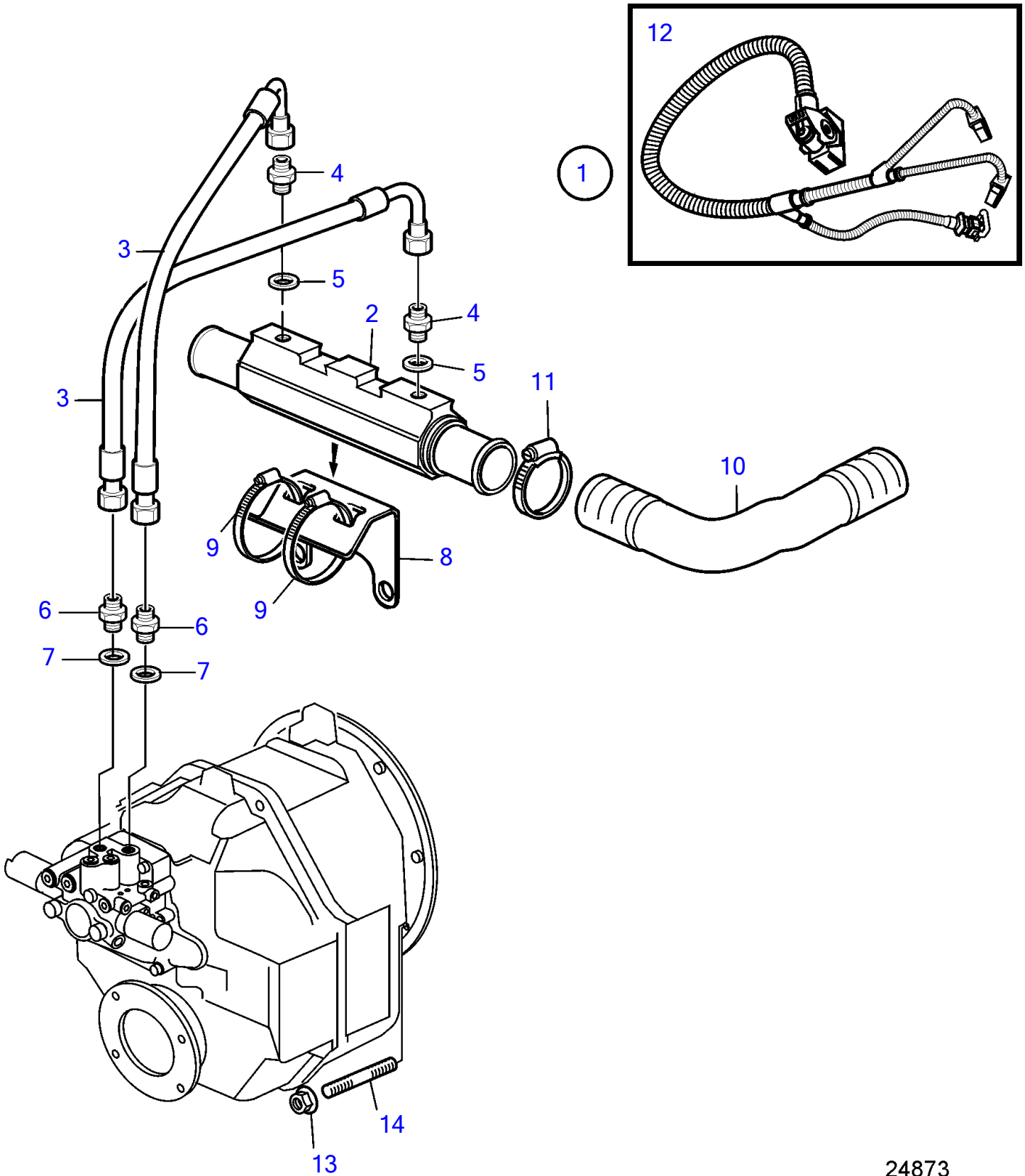

24873

D3-110I-D, D3-110I-E, D3-110I-F, D3-140I-E, D3-140I-F, D3-150I-D, D3-150I-E, D3-150I-F, D3-170I-D, D3-170I-E, D3-170I-F, D3-200I-D, D3-200I-E, D3-200I-F, D3-220I-D, D3-220I-E, D3-220I-F

REF	PART NO.	QTY	DESCRIPTION
1		1	Installation kit
2	21149930	1	• Oil cooler
3	3584428	2	• Hose
4	963948	2	• Nipple
5	976930	2	• Gasket
6	941750	2	• Nipple
7	11978	2	• Washer
8	3584439	1	• Bracket
9	961673	2	• Hose clamp
10	21285072	1	• Hose
11	994561	4	• Hose clamp
12	40005753	1	• Wiring harness
13	971095	4	Flange nut
14	953067	6	Stud
15	946752	10	Flange screw