

MD22L-B, MD22P-B, TMD22-B, TMD22P-C, TAMD22P-B

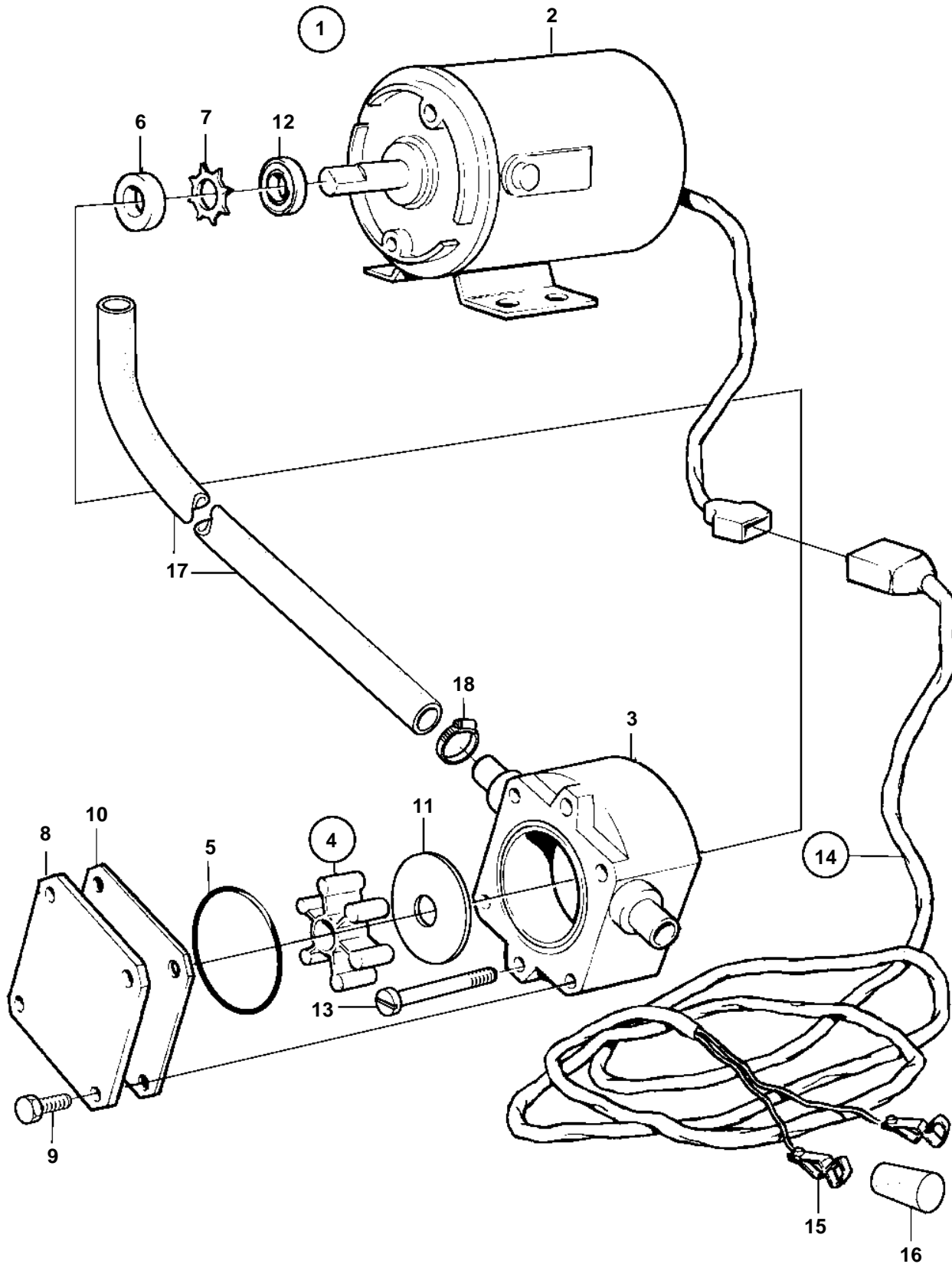

18186

MD22L-B, MD22P-B, TMD22-B, TMD22P-C, TAMD22P-B

REF	PART NO.	QTY	DESCRIPTION	NOTES
1	843410	1	Oil bilge pump	24V
2	842222	1	· Electrical motor	
3	844015	1	· · Housing	
4	844022	1	· · Impeller kit	
5		1	· · · O-ring	
6		1	· · · Sealing ring	
7		1	· · · Lock ring	
8	844018	1	· · Cover	
9	844021	4	· · Screw	
10	844017	1	· · Wear washer	
11	844016	1	· · Wear washer	
12	844019	1	· · Oil deflector ring	
13	969518	2	· · Screw	(847464)
14	843113	1	· Cable trunk	
15	844280	2	· · Cable terminal	
16		1	· · Isolator	BLACK
		1	· · Isolator	RED
17	943707	X	· Rubber hose	
18	943471	3	· Hose clamp	