

DP-D1

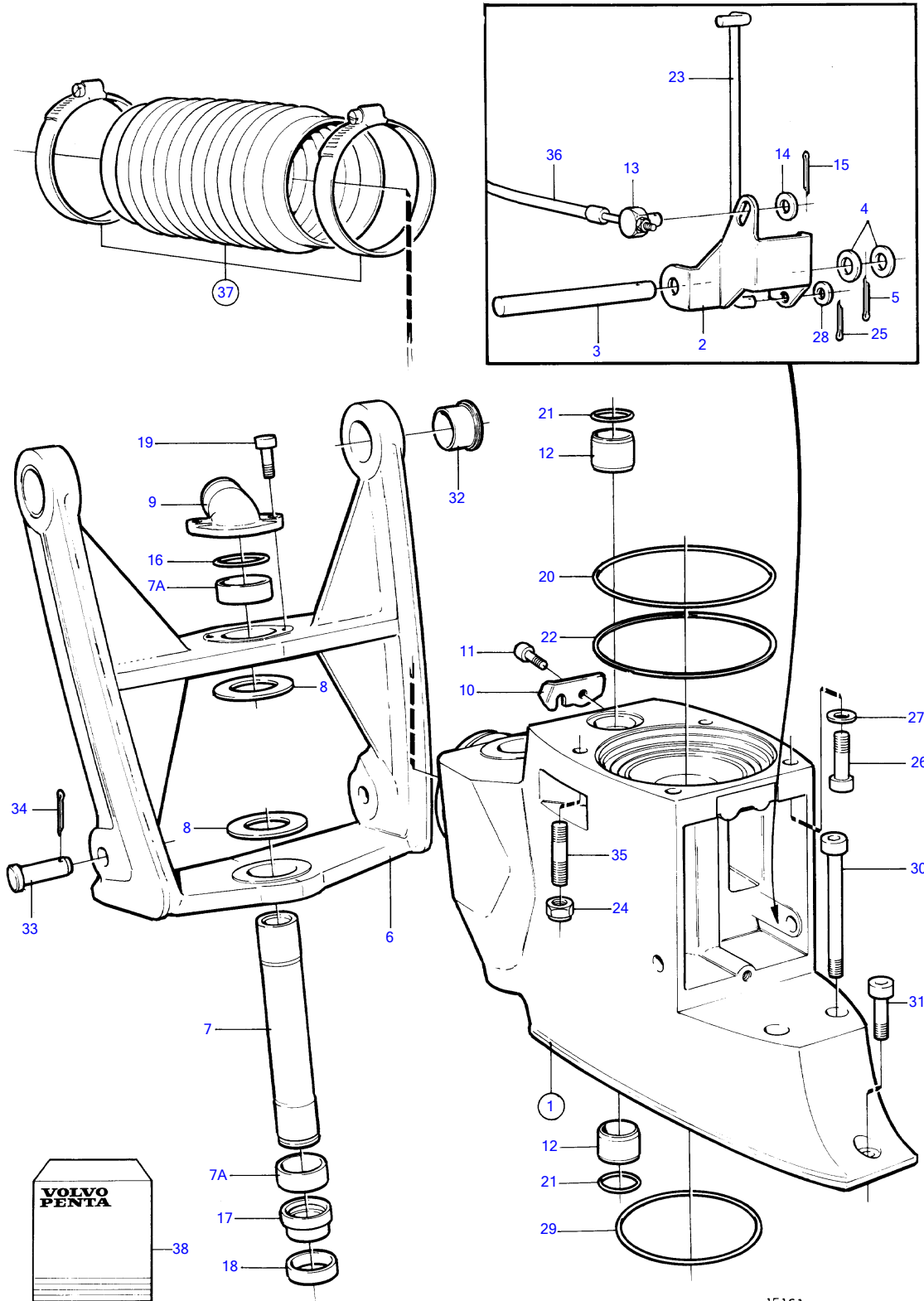

Upd:2012-01-30

15161

15161

7734180-44-614

DP-D1

REF	PART NO.	QTY	DESCRIPTION	SEE SEC.	NOTES
1	872850	1	Intermediate housing		
2	872977	1	• Yoke		
3	897447	1	• Shaft		
4	941670	2	• Washer		
5	17253	1	• Split pin		Included in gasket kit.
6	872853	1	Fork		
7	872753	1	Steering knuckle		
7A	872756	2	Bearing bushing		
8	3860808	1	Shim kit		
9	872752	1	Hose connection		
10	872940	1	Cable attachment		
11	940168	1	Hexagon screw		
12	872986	2	Sleeve		
13	3852329	1	Cube		
14	940191	1	Washer		
15	17276	1	Split pin		Included in gasket kit.
16	979254	1	O-ring		
17	873534	1	Retainer		
18	872755	1	Sealing ring		Included in gasket kit.
19	940169	2	Hexagon screw		
20	925259	1	O-ring		Included in gasket kit.
21	125017	2	O-ring		Included in gasket kit.
22	941826	X	Shim		TH=0.05mm
	941827	X	Shim		TH=0,20mm
	948230	X	Shim		TH=0.35mm
23	872822	1	Control rod		
24	941885	2	Lock nut		
25	17253	1	Split pin		Included in gasket kit.
26	959456	2	Hex. socket screw		
27	853095	2	Washer		
28	940191	1	Washer		
29	925256	1	O-ring		Included in gasket kit.
30	941808	2	Hex. socket screw		
31	941809	1	Hex. socket screw		
32	876507	1	Bushing kit		Included in gasket kit.
33	872126	2	Clevis pin		
34	967707	2	Split pin		
35	977241	2	Stud		
36		1	Control cable	231	
37		1	Bellows kit		
38	876266	1	Gasket kit, upper gear		See group 99
	876267	1	Gasket kit, lower gear		See group 99