

KAMD300-A

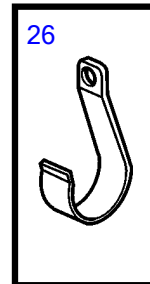
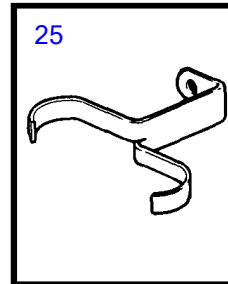
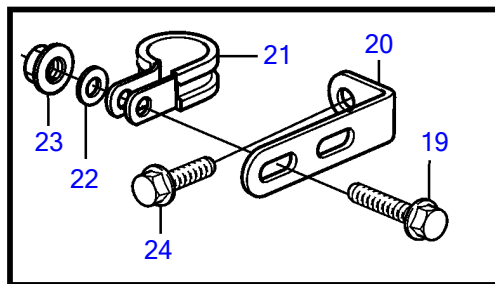
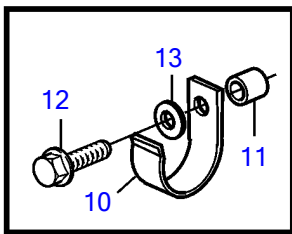
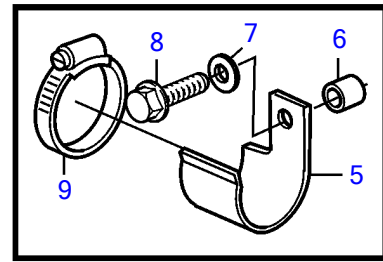
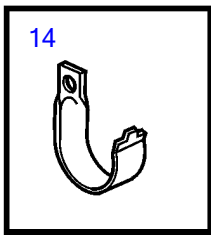
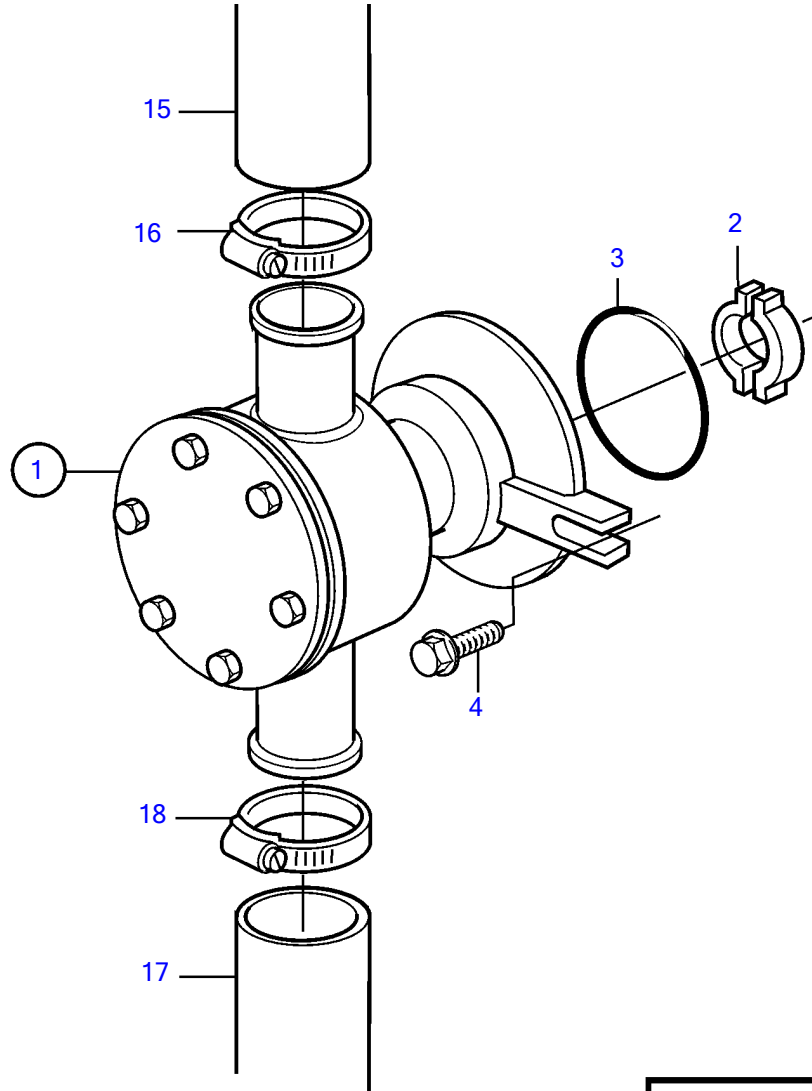

KAMD300-A

| REF | PART NO. | QTY | DESCRIPTION | SEE SEC. | NOTES |
|-----|----------|-----|----------------------|----------|------------------------------|
| 1 | 3583095 | 1 | Sea water pump | | |
| | | | . | | |
| | | | . | 3400 | |
| 2 | 858467 | 1 | Companion flange | | |
| 3 | 968971 | 1 | O-ring | | |
| 4 | 945444 | 2 | Flange screw | | |
| 5 | 3580758 | 1 | Bracket | | |
| 6 | 843075 | 1 | Spacer sleeve | | |
| 7 | 955894 | 1 | Washer | | |
| 8 | 945444 | 2 | Flange screw | | |
| 9 | 961669 | 1 | Hose clamp | | |
| 10 | 857045 | 2 | Clamp | | |
| 11 | 843075 | 1 | Spacer sleeve, inlet | | L=16mm |
| | 1660462 | 1 | Spacer sleeve | | |
| 12 | 965180 | 1 | Flange screw | | L=60mm |
| 13 | 955894 | 2 | Washer | | |
| 14 | 834974 | 1 | Clamp | | |
| 15 | 861335 | 1 | Hose | | Sea water pump-intercooler. |
| 16 | 943476 | 1 | Hose clamp | | |
| 17 | 861738 | 1 | Hose | | Reverse gear-sea water pump. |
| 18 | 961669 | 2 | Hose clamp | | |
| 19 | 946544 | 1 | Flange screw | | |
| 20 | 965558 | 1 | Bracket | | |
| 21 | 967645 | 1 | Clamp | | |
| 22 | 955893 | 1 | Washer | | |
| 23 | 949278 | 1 | Flange lock nut | | |
| 24 | 947760 | 1 | Flange screw | | |
| 25 | 3580794 | 1 | Bracket | | |
| 26 | 3580798 | 1 | Clamp | | |