

TAMD41B

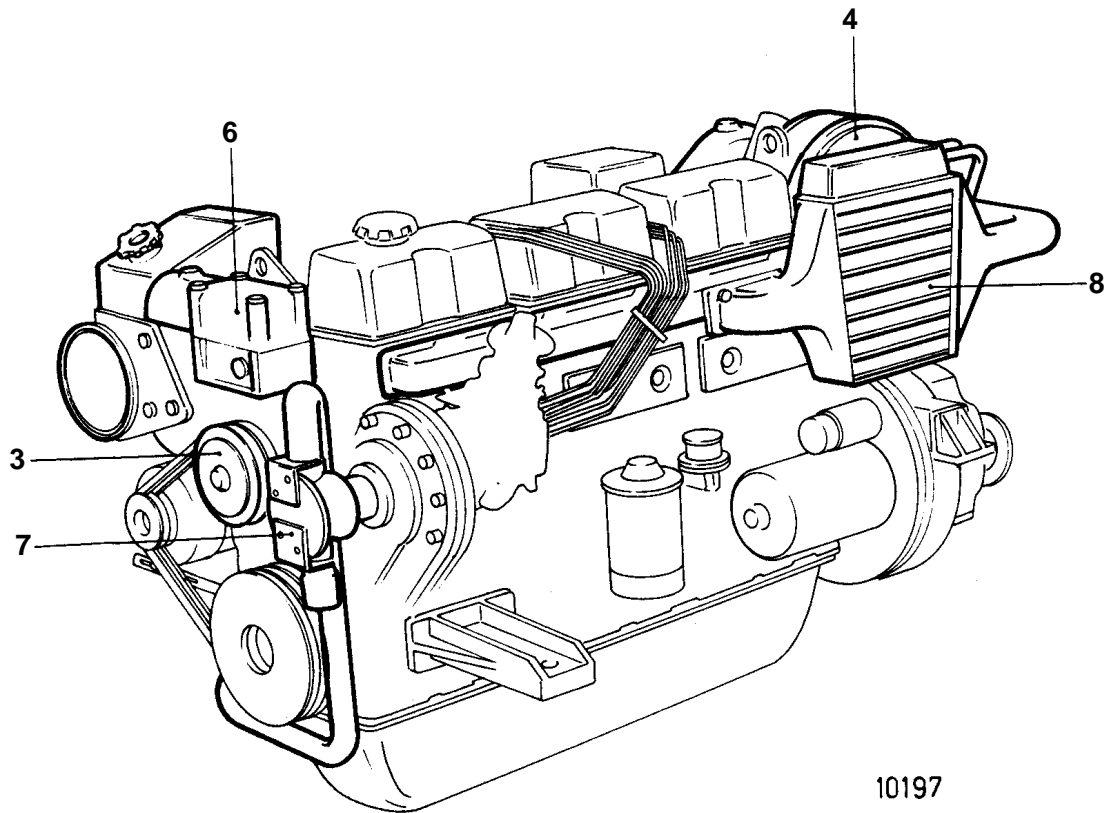
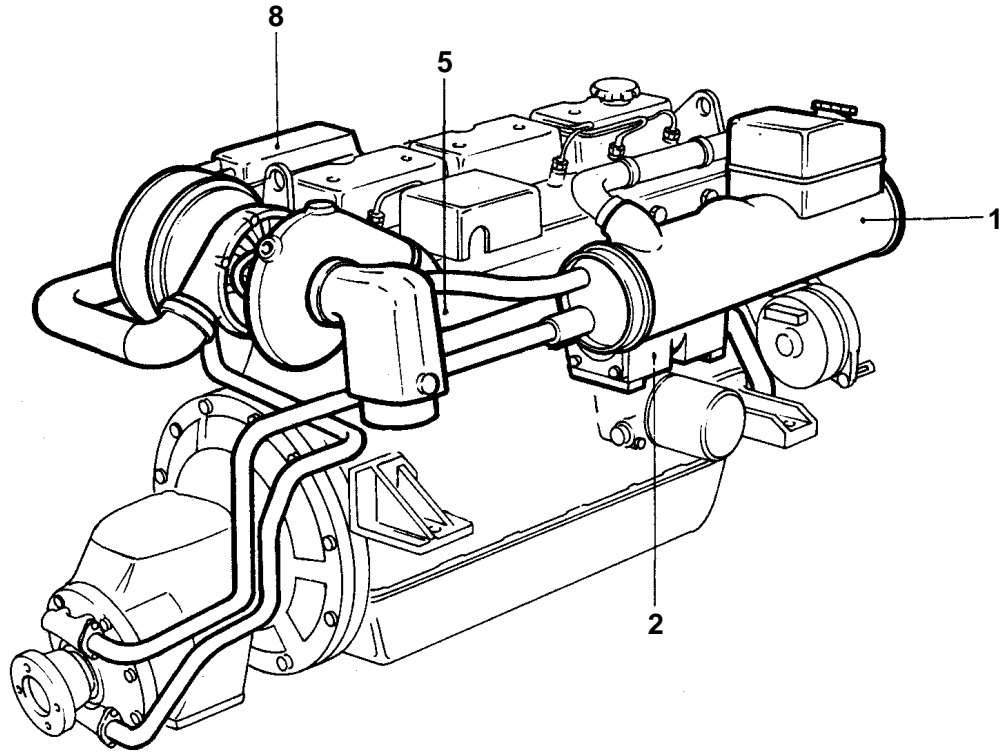

10197

TAMD41B

REF	QTY	DESCRIPTION	SEE SEC.
1	1	HEAT EXCHANGER WITH INSTALLATION COMPONENTS	02B-0900
2	1	OIL COOLER WITH INSTALLATION COMPONENTS	02B-1300
3	1	CIRCULATION PUMP WITH INSTALLATION COMPONENTS	02B-1050
4	1	TURBO AND AIR FILTER WITH INSTALLATION COMPONENTS	02B-2060
5	1	INDUCTION- AND EXHAUST MANIFOLD WITH INSTALLATION COMPONENTS	02B-2354
6	1	THERMOSTAT HOUSING WITH INSTALLATION COMPONENTS	02B-2600
7	1	SEA WATER PUMP WITH INSTALLATION COMPONENTS	02B-1130
8	1	AFTER COOLER WITH INSTALLATION COMPONENTS	02B-2430