

TMD31A

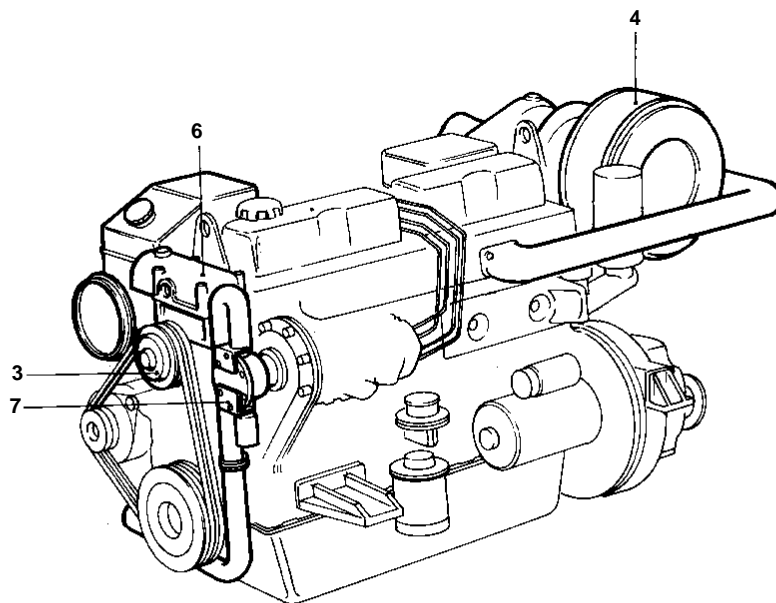
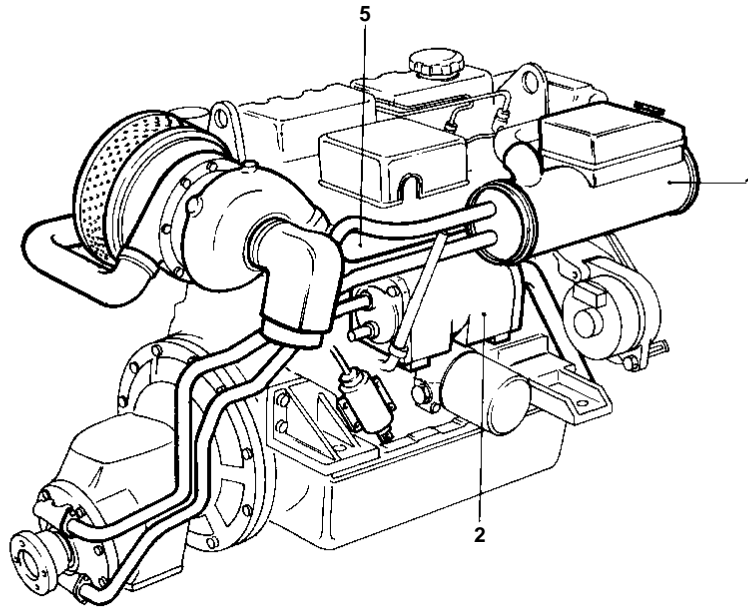

8409

TMD31A

REF	QTY	DESCRIPTION	SEE SEC.
1	1	HEAT EXCHANGER WITH INSTALLATION COMPONENTS	02B-0850
2	1	OIL COOLER WITH INSTALLATION COMPONENTS	02B-1280
3	1	CIRCULATION PUMP WITH INSTALLATION COMPONENTS	02B-0953
4	1	TURBO AND AIR FILTER WITH INSTALLATION COMPONENTS	02B-2035
5	1	INDUCTION- AND EXHAUST MANIFOLD WITH INSTALLATION COMPONENTS	02B-2260
6	1	THERMOSTAT HOUSING WITH INSTALLATION COMPONENTS	02B-2475
7	1	SEA WATER PUMP WITH INSTALLATION COMPONENTS	02B-1100