

D25A-MT, D25A-MS, D30A-MT, D30A-MS

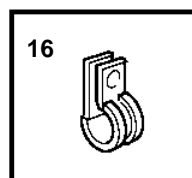
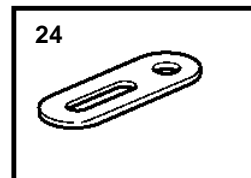
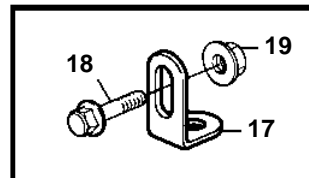
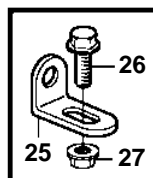
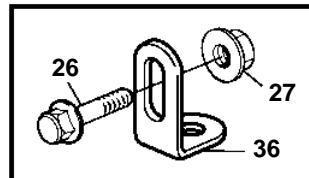
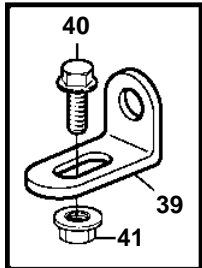
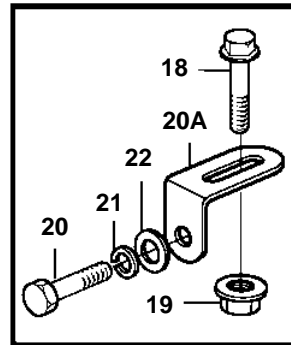
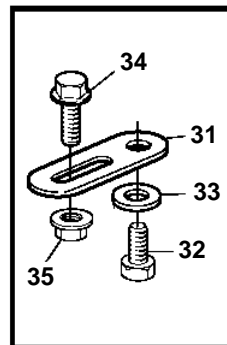
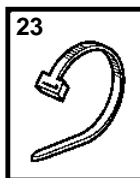
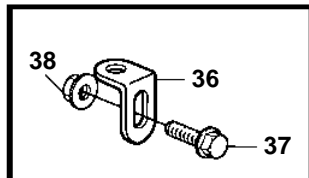
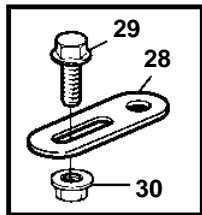
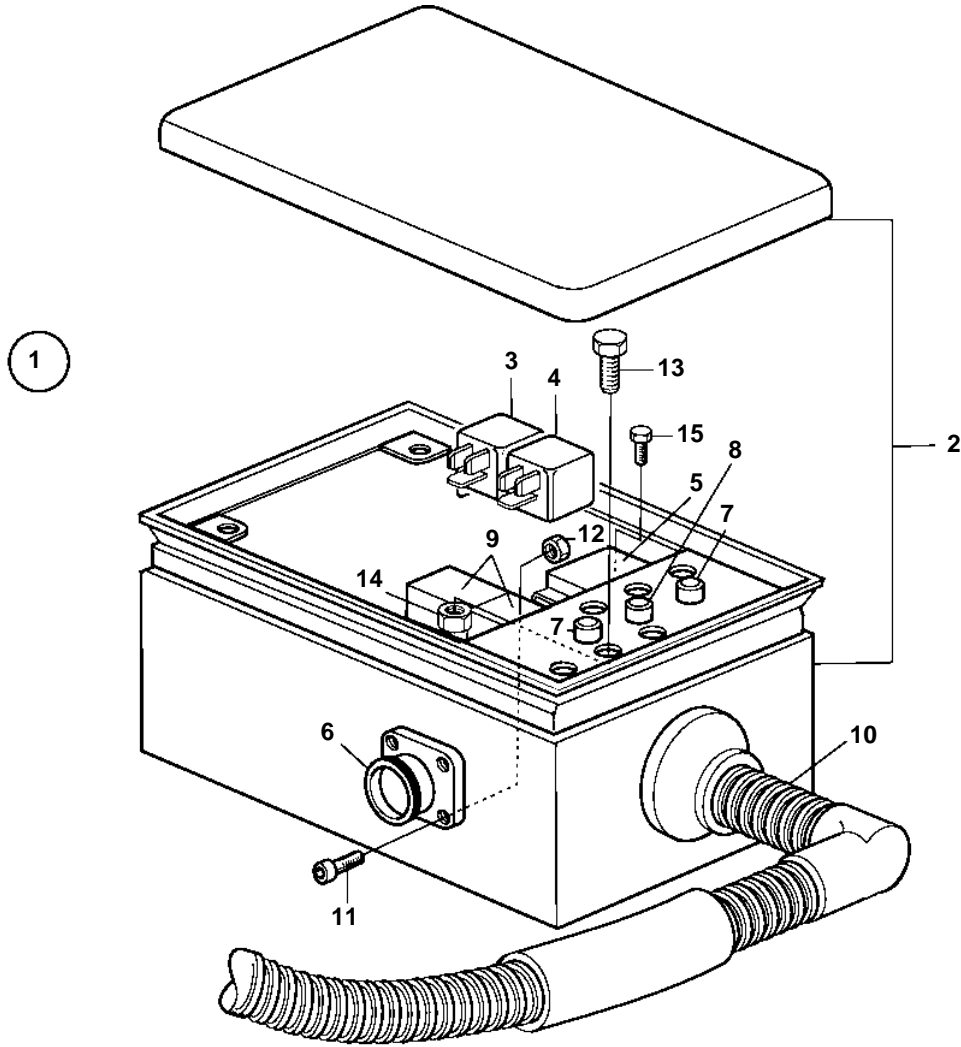

## D25A-MT, D25A-MS, D30A-MT, D30A-MS

REF	PART NO.	QTY	DESCRIPTION	NOTES
1		1	Wiring harness	
2	3832498	1	• Box	
3	3171420	1	• Relay	
4	3171420	1	• Relay	
5	874100	1	• Timer relay	
6	846611	1	• Sleeve connector	
7	873952	2	• Fuse	
8	874579	1	• Fuse	
9	977184	2	• Tab housing	
10	874305	1	• Wiring harness	
11	956046	4	• Screw	
12	955778	4	• Nut	
13	969408	6	• Screw	(956079)
14	963104	6	• Nut	
15	956074	4	• Screw	
16	947827	3	Clamp	D=25,4mm
	949747	3	Clamp	D=15,9mm
	949746	3	Clamp	D=12,7mm
	945081	4	Clamp	D=22,2mm
17	965553	2	Bracket, cooling water temp sensor	L=40mm
18	946440	3	Flange screw	M8
19	945408	3	Flange nut	M8
20	3832042	1	Screw, clamp, stop solenoid	M10
20A	965553	1	Bracket, clamp, stop solenoid	
21	3832233	1	Spring washer, clamp, stop solenoid	
22	3832214	1	Washer, clamp, stop solenoid	
23	948211	2	Strip clamp	D=67mm, L=270mm
	948702	3	Strip clamp	D=15mm, L=95mm
	948616	6	Strip clamp	D=85mm, L=375mm
	948702	3	Strip clamp	D=15mm, L=95mm
24	3836034	1	Bracket	
25	965557	1	Bracket, cable, turbopress. sensor	
26	946440	2	Flange screw	
27	945408	2	Flange nut	
28	965536	1	Bracket, main cable	
29	946440	1	Flange screw	
30	945408	1	Flange nut	
31	965536	1	Bracket, cable, oil pressure	
32	3835725	1	Screw	
33	3832245	1	Spring washer	
34	946440	1	Flange screw	
35	945408	1	Flange nut	
36	965557	2	Bracket	Cable, water temp and oil pressure sensor.
37	946440	2	Flange screw	
38	945408	2	Flange nut	
39		1	Bracket	
40	946440	1	Flange screw	
41	945408	1	Flange nut	