

D2-75F

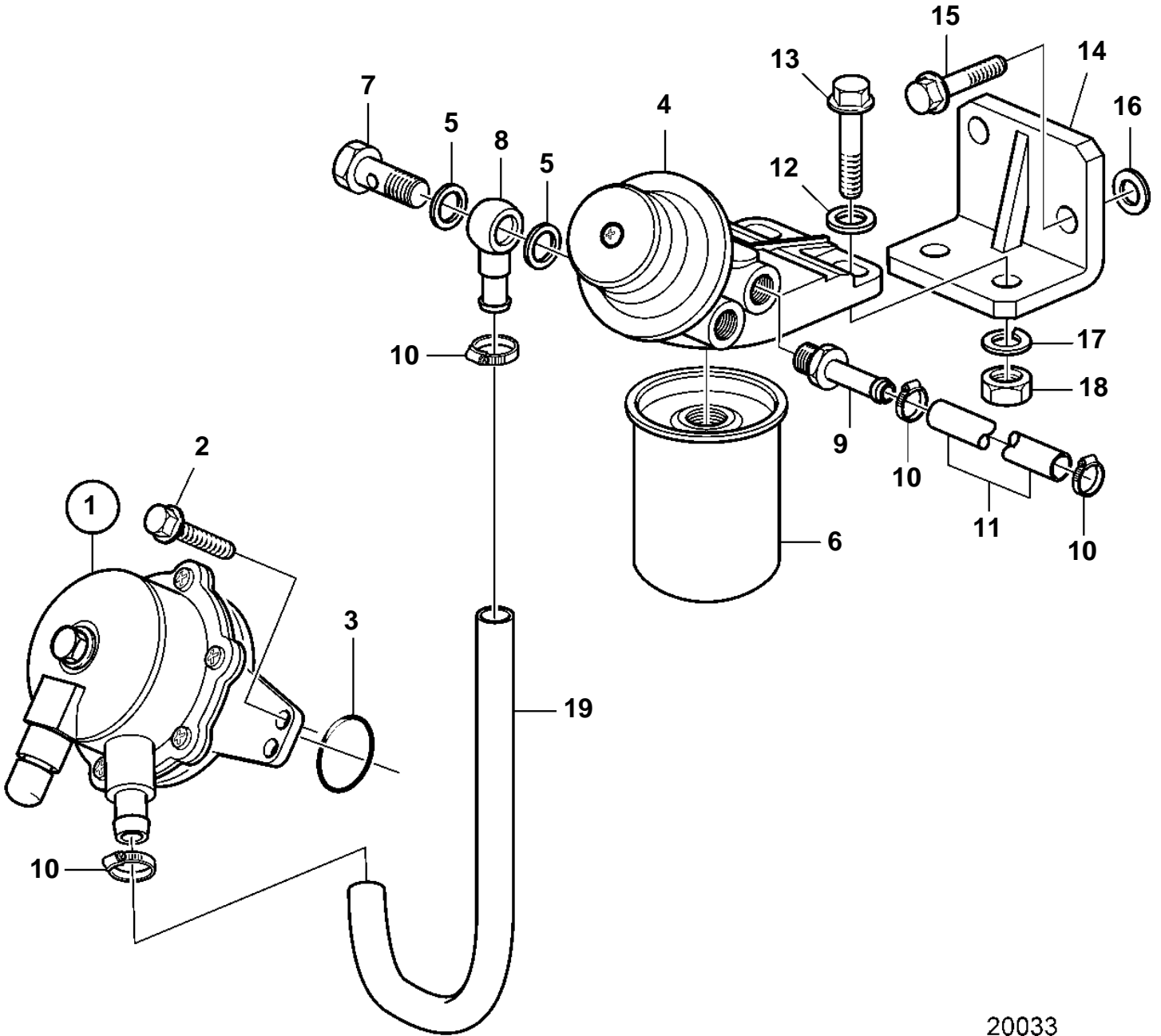

20033

D2-75F

REF	PART NO.	QTY	DESCRIPTION
1	21132189	1	Feed pump
2	945358	1	Flange screw
3	3589332	1	O-ring
4	3584125	1	Fuel filter
5	969011	3	Gasket
6	861477	1	Fuel filter
7	3886416	1	Banjo nipple
8	3580101	1	Banjo nipple
9	3809680	1	Nipple
10	961664	4	Hose clamp
11	3809681	1	Hose
12	3580031	2	Washer
13	3583783	2	Screw
14	3584424	1	Bracket
15	21246643	2	Hexagon screw
16	191169	2	Washer
17	3580015	2	Spring washer
18	971071	2	Hexagon nut
19	3809681	1	Hose