

D2-55F

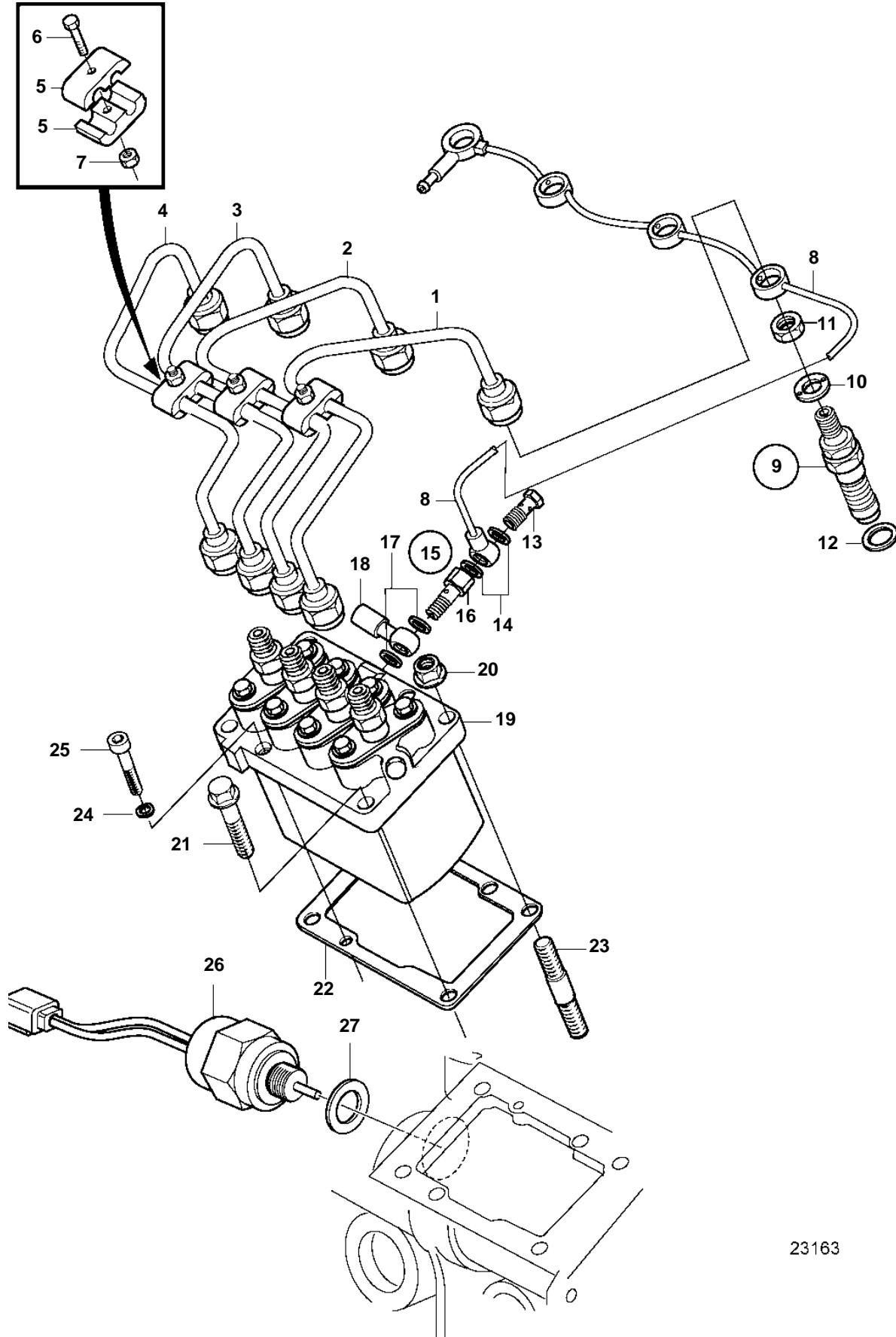

23163

D2-55F

REF	PART NO.	QTY	DESCRIPTION	SEE SEC.	NOTES
1	3583524	1	Delivery pipe		
2	3583525	1	Delivery pipe		
3	3583526	1	Delivery pipe		
4	3583527	1	Delivery pipe		
5	3886457	6	Clamp		
6	947542	3	Flange screw		
7	945407	3	Flange nut		
8	21194397	1	Return pipe		
9	3580592	4	Injector		
	3803442	4	Injector, exch, exch		
				232	
10	3580631	1	· Gasket		
11		1	· Nut		
12	3580077	4	Gasket		
13	3580599	1	Screw		
14	21427938	2	Gasket		
15			Injection pump		
			· Injection pump		
	3801337		· Injection pump, exch, exch		
16	3580628	1	· Hollow screw		
17	11994	2	· Gasket		
18	3580627	1	· Banjo nipple		
19		1	· Injection pump		
20	948645	3	Flange lock nut		
21	3583769	3	Screw		
22	3583764	1	Shim		TH = 0.2mm
	21194394	1	Shim		TH = 0.25mm
	3583765	1	Shim		TH = 0.3mm
	21194396	1	Shim		TH = 0.35mm
	3583766	1	Shim		TH = 0.4mm
	3583767	1	Shim		TH = 0.50mm
	3583768	1	Shim		TH = 0.5mm
23	3583705	3	Stud		
24	861847	1	Washer		
25	3809331	1	Screw		
26	3584127	1	Stop solenoid		
27	3580092	1	Sealing ring		