

COMMON

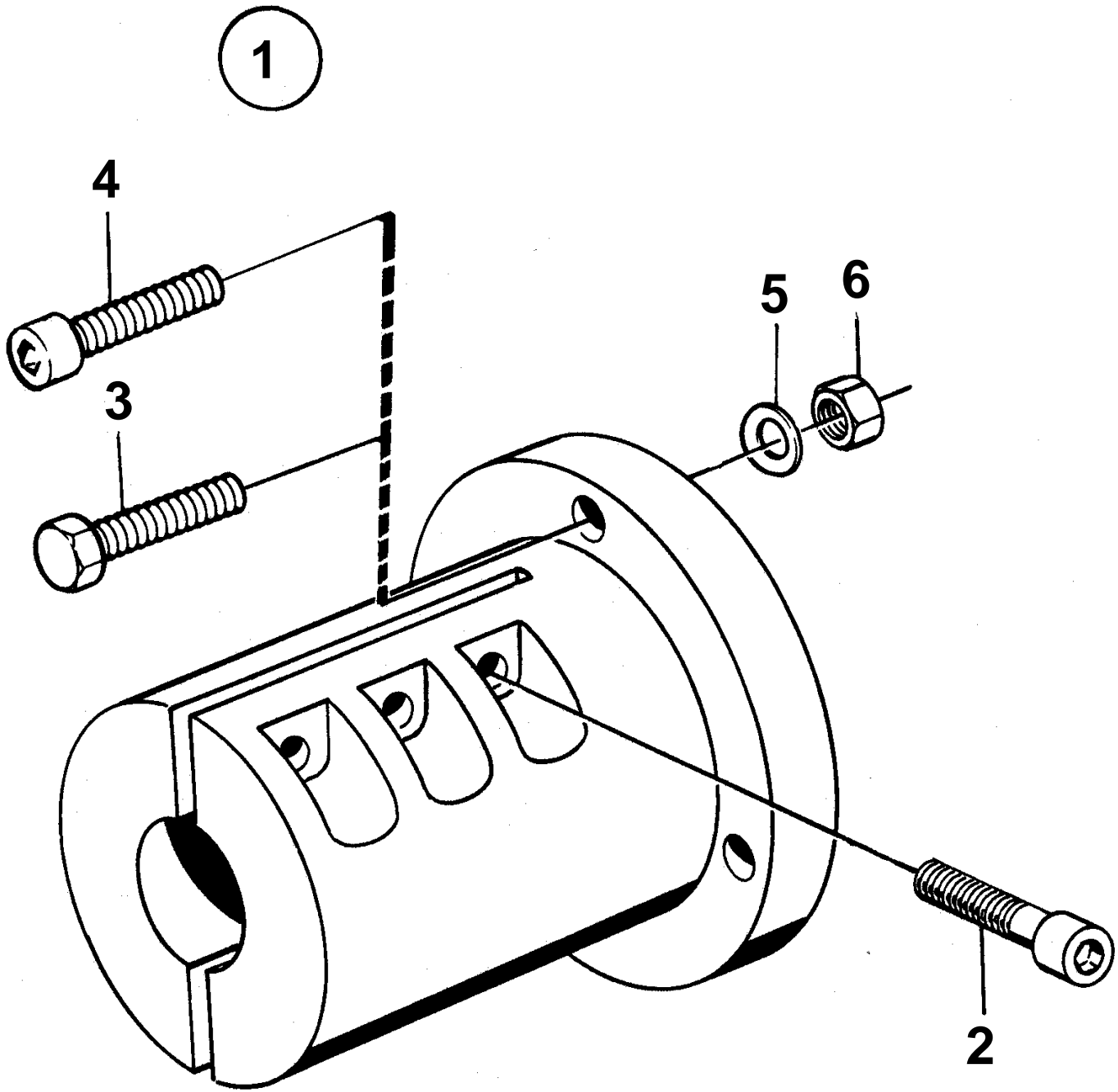

11038

COMMON

REF	PART NO.	QTY	DESCRIPTION	NOTES
1	827927	1	Clamp coupling	30MM HOLE FOR PROPELLER SHAFT.
2	949068	6	· Screw	
3	955319	4	· Screw	L = 35 MM
4	959239	4	· Screw	L = 30 MM
5	941908	4	· Spring washer	
6	955783	4	· Nut	