

# INSTALLATION INSTRUCTIONS

**ENG**

## **Installation Instructions**

Universal tachometer. Petrol, Diesel.  
(12V, 24V)

**GER**

## **Einbauanleitung**

Universaldrehzahlmesser.  
Benzin, Diesel. (12V, 24V)

**FRE**

## **Instructions de montage**

Compte-tours universal.  
Essence, Diesel. (12V, 24V)

**SPA**

## **Instucciones para el montaje**

Cuentarrevoluciones universal.  
Gasolina, Diesel. (12V, 23V)

**ITA**

## **Istruzioni di montaggio**

Contagiri universale. Motori a benzina  
e Diesel. (12V, 24V)

**SWE**

## **Monteringsanvisning**

Universalvarvräknare. Bensin, Diesel  
(12V, 24V)

## **IMPORTANT!**

This batch with its accompanying instructions is produced for Volvo Penta's service workshops, boat-builders, machine manufacturers and other authorized workshops which have personnel with qualified professional training.

The installation instructions are only produced for professional use and are not intended for non-professional use. Volvo Penta will not assume any liability whatsoever for damage incurred, either damage to materials or personal injury, which may result if the installation instructions are not followed or if the work is carried out by non-professional personnel.

## **WICHTIG!**

Dieser Satz mit vorliegender Einbauanleitung ist für Volvo Penta Kundendienst-werkstätten, Werften, Maschinenbauer und für andere ermächtigte Werkstätten mit beruflich geschultem Personal vorgesehen.

Die Einbauanleitung ist nur für den berufsmäßigen Gebrauch vorgesehen und nicht für unprofessionelle Anwendung gedacht. Volvo Penta übernimmt nicht die geringste Haftung für irgendwelchen Schäden an Personen oder Sachen, die als Folge einer Nichtbefolgung der Einbauanleitung oder wegen Ausführung der darin beschriebenen Arbeiten durch nicht beruflich geschulte Personen entstehen.

## **IMPORTANT!**

Ce kit, avec instructions de montage, est destiné aux ateliers de service Volvo Penta, aux constructeurs de bateaux et autres ateliers de construction agréés avec un personnel qualifié.

Les instructions de montage sont exclusivement conçues pour une utilisation professionnelle. Volvo Penta se dégage de toute responsabilité pour d'éventuels endommagements, corporels ou matériels, résultant du non respect des instructions ou d'un travail effectué par un personnel non compétent.

## **IMPORTANTE!**

El presente juego con las instrucciones de montaje se destina a los talleres de servicio Volvo Penta, constructores de embarcaciones y máquinas y a otros talleres autorizados que cuentan con personal capacitado.

Las instrucciones de montaje están destinadas únicamente para uso profesional, por lo que Volvo Penta no aceptará responsabilidad alguna por cualquier daño, tanto personal como material, resultado de no haber seguido las instrucciones de montaje o de haber sido efectuado el trabajo por personal que no está debidamente capacitado.

## **IMPORTANTE!**

Questo kit e le relative istruzioni di montaggio sono stati realizzati per le officine di servizio Volvo Penta, i cantieri, i fabbricanti di macchine e tutte le altre officine autorizzate il cui personale ha ricevuto un addestramento qualificato e specializzato.

Le istruzioni di montaggio sono state redatte esclusivamente per uso professionale e non sono adatte all'uso non professionale. La Volvo Penta non si assume alcuna responsabilità per eventuali danni alle cose o alle persone, derivanti da trascuratezza nel seguire le istruzioni di montaggio oppure dall'esecuzione dei lavori da parte di personale non qualificato.

## **VIKTIGT!**

Denna sats med föreliggande monteringsanvisning är framtagen för Volvo Pentas serviceverkstäder, båtbyggare, maskintillverkare och övriga auktoriserade verkstäder som har personal med kvalificerad fackutbildning.

Monteringsanvisningen är enbart framtagen för yrkesbruk och är inte avsedd för icke yrkesmässig användning. Volvo Penta påtager sig inget som helst ansvar för eventuella skador, såväl materiella som personsador, som kan bli följden om monteringsanvisningen ej följs, eller om arbetet utförs av icke yrkeskunnig

## **VIGTIGT!**

Dette sæt med tilhørende monteringsvejledning er blevet udviklet for Volvo Pentas serviceværksteder, bådbyggere, maskinproducenter og andre autoriserede værksteder, som har medarbejdere med kvalificeret, faglig uddannelse.

Monteringsvejledningen er udelukkende beregnet til professionel anvendelse og ikke til hobby- eller fritidsbrug. Volvo Penta påtager sig intet som helst ansvar for eventuelle skader på såvel materiel som personer, som kan være en følge af at monteringsvejledningens anvisninger ikke blev overholdt, eller hvis arbejdet blev udført af ikke-professionelt personale.

## **TÄRKEÄÄ!**

Tämä sarja ja asennusohje on tarkoitettu Volvo Pentan huoltokorjaamoille, veneenrakentajille, konevalmistajille ja muille valtuutetuille korjaamoille, joiden henkilökunta on saanut pätevän ammattikoulutuksen.

Asennusohje on tarkoitettu ainoastaan ammattikäyttöön. Volvo Penta ei vastaa mahdollisista materiaali- tai henkilövahingoista, joita asennusohjeen laiminlyöminen tai ammattitaidottoman henkilökunnan suorittama asennustyö voi aiheuttaa.

## **BELANGRIJK!**

Deze set met de bijgevoegde montage-aanwijzing is ontwikkeld voor de werkplaatsen van Volvo Penta, botenbouwers, machinefabrikanten en overige bevoegde werkplaatsen, die personeel hebben met een gekwalificeerde vakopleiding.

De montage-aanwijzing is alleen ontwikkeld voor professioneel gebruik en is niet bedoeld voor niet-professioneel gebruik. Volvo Penta neemt geen enkele verantwoordelijkheid op zich voor eventuele schade, zowel materiële schade als persoonlijk letsel, die het gevolg kan zijn als de montage-aanwijzing niet wordt gevolgd, of als het werk wordt uitgevoerd door niet-vakkundig personeel.

## **IMPORTANTE!**

Este jogo, juntamente com as respectivas instruções de montagem, foi concebido para as oficinas de serviço da Volvo Penta, construtores navais, construtores de máquinas e outras oficinas autorizadas, com pessoal devidamente formado.

As instruções de montagem foram concebidas unicamente para utilização profissional e não se destinam a utilização não profissional. A Volvo Penta não se responsabiliza por quaisquer danos eventuais, tanto materiais como pessoais, que possam resultar no caso de as instruções de montagem não serem seguidas, ou se os trabalhos forem executados por pessoal não profissional.

## **ΠΡΟΣΟΧΉ!**

Το περιεχόμενο αυτού του πακέτου μαζί με τις οδηγίες συναρμολόγησης που το ακολουθούν είναι ειδικά επιλεγμένο για συνεργεία σέρβις της Volvo Penta, ναυπηγεία, κατασκευαστές μηχανών και για λοιπά εξουσιοδοτημένα συνεργεία που διαθέτουν εξειδικευμένο προσωπικό.

Οι οδηγίες συναρμολόγησης προορίζονται μόνο για επαγγελματική χρήση και δεν αποσκοπούν για χρήση από μη επαγγελματίες. Η Volvo Penta δεν αναλαμβάνει απολύτως καμία ευθύνη για πιθανές ζημιές, τόσο υλικές όσο και προσωπικές, που μπορούν να προκληθούν επειδή δεν ακολουθούνται οι οδηγίες συναρμολόγησης ή επειδή η εργασία εκτελείται από μη εξειδικευμένο προσωπικό.

INSTALLATION IN SQUARE FRAME  
 EINBAU IN VIERKANTRAHMEN  
 MONTAGE DANS UN CADRE CARRE

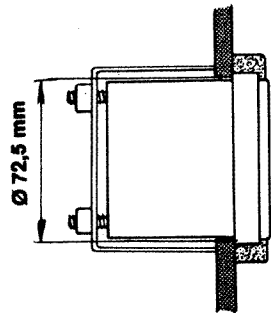

MONTAJE EN MARCO CUADRANGULAR  
 MONTAGGIO NELLA CORNICE QUADRATA  
 MONTERING I FYRKANTSRAM

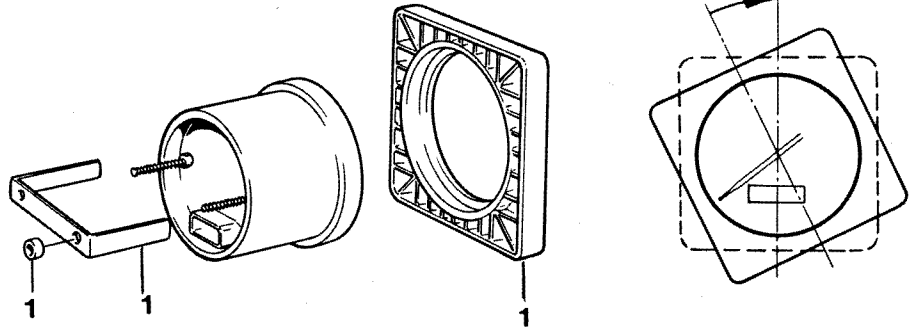

INSTALLATION IN VOLVO PENTA BEZEL  
 EINBAU IN VOLVO PENTA-RING  
 MONTAGE DANS UNE BAGUE VOLVO PENTA

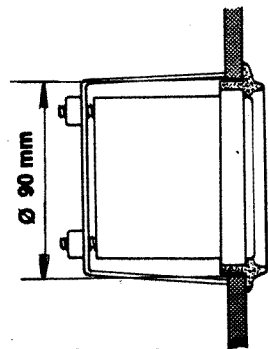

MONTAJE EN EL ARO DE VOLVO PENTA  
 MONTAGGIO NELL'ANELLO VOLVO PENTA  
 MONTERING I VOLVO PENTA RING

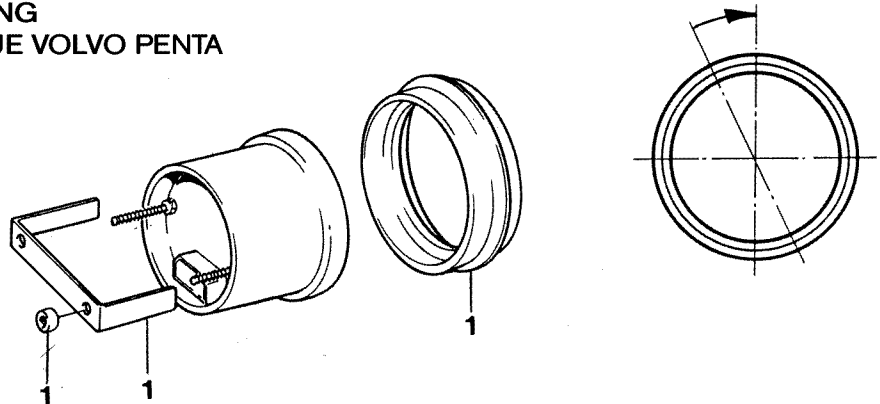

FLUSH INSTALLATION  
 VERDECKTEINBAU  
 MONTAGE ENCASTRE  
 MONTAJE A NIVEL  
 MONTAGGIO A FILO  
 FLUSHMONTERING

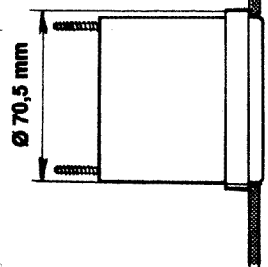

INSTALLATION IN VOLVO PENTA PANEL  
 EINBAU IN VOLVO PENTA-TAFEL  
 MONTAGE DANS UN TABLEAU VOLVO PENTA  
 MONTAJE EN EL PANEL DE VOLVO PENTA  
 MONTAGGIO NEL PANNELLO VOLVO PENTA  
 MONTERING I VOLVO PENTA PANEL

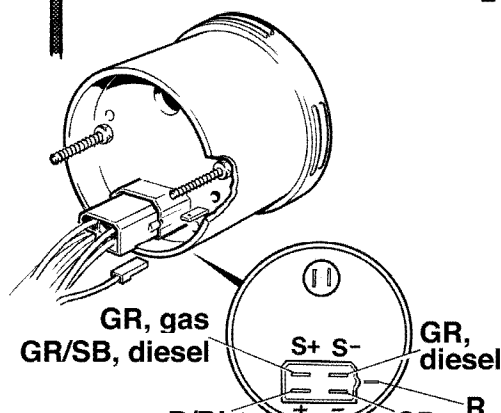
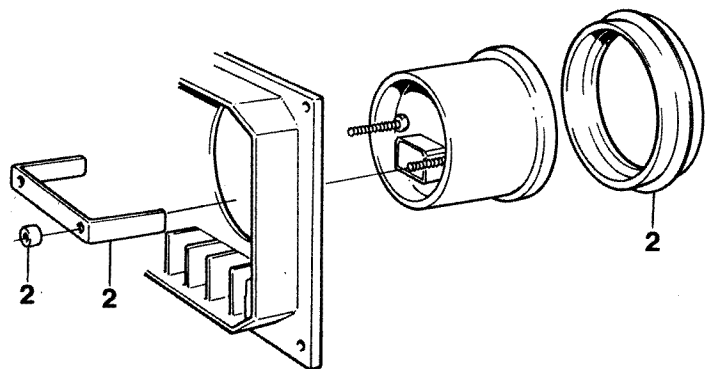

- 1) Not included in tachometer kit
- 1) Nicht im Drehzahlmessersatz eingeschlossen
- 1) ne fait pas partie du kit de compte-tours
- 1) No se incluye en el kit del cuentarrevoluciones
- 1) Non compreso nel kit del contagiri
- 1) Ingår ej i varvräknersats
- 2) Included in Volvo Penta instrument panel
- 2) In Volvo Pentas Instrumententafel enthalten
- 2) fait partie du tableau de bord Volvo Penta
- 2) Se incluye en el panel de instrumentos de Volvo Penta
- 2) Compreso nel pannello strumenti Volvo Penta

ENG

Before the tachometer is used, the correct code for the engine must be set.

**INSTRUCTION FOR CODE SETTING**

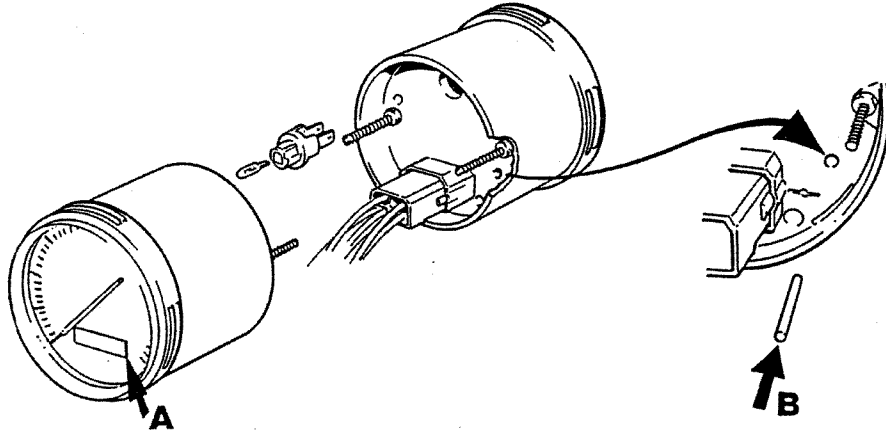

Setting step		Shown on display A	Descriptions
Connected to system voltage		<b>COdE</b>	
Press in pin B and release pin B (Pin B is not included in the tachometer kit)		<b>Cd1</b>	
Press in pin B		<b>Cd3</b> <b>Cd4</b> <b>Cd5</b>	Codes are scrolled at 1 second intervals
Remove pin B when the correct code is displayed*		<b>Cd3</b>	This is your code (compare with code table)
* = IMPORTANT Wait for 10 seconds with the unit connected to system voltage to confirm the code setting.		<b>0.0</b>	Switches to hours counting

# INSTRUCTION FOR FINE ADJUSTMENT

(Intended for twin installation, carry out as necessary)

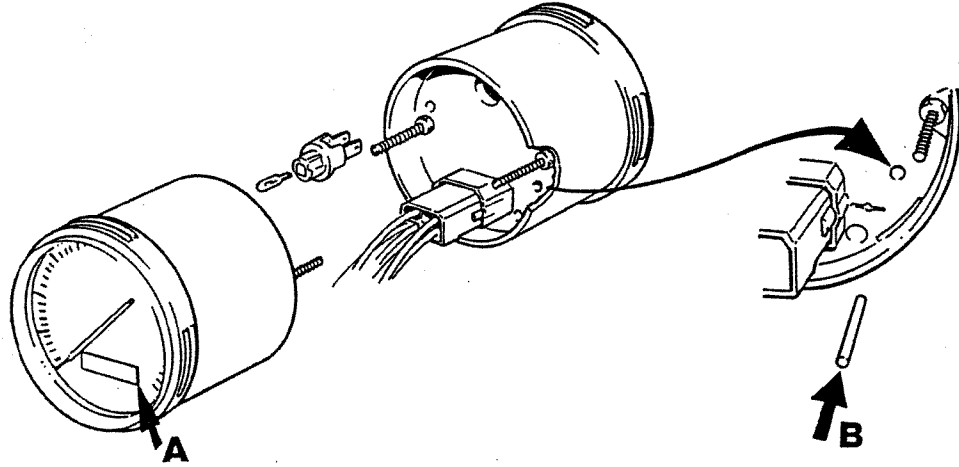



Setting step		Shown on display A	Descriptions
System voltage on, press pin B		<b>A 0,0</b>	A = Fine adjustment mode
Remove pin B		<b>A 0,0</b>	Displays the current difference to normal setting.
Press pin B		<b>A 2,5</b> ↑	Display increments, display shows current difference to normal setting
Remove pin B*		<b>A 2,5</b>	Displays the current difference to normal setting.
Press pin B		<b>A -1,5</b> ↓	Display decrements, display shows current difference to normal setting
Remove pin B*		<b>A -1,5</b>	Displays the current difference to normal setting.
* = IMPORTANT Wait for 10 seconds with the unit connected to system voltage to confirm the code setting.		<b>0,0</b>	Switches to hours counting

**A 2,5**

This figure shows the difference in percent of current scale value. The step between the figures is 0.5.

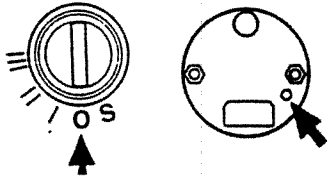
# INSTRUCTION FOR CHANGING A PREVIOUSLY SET CODE

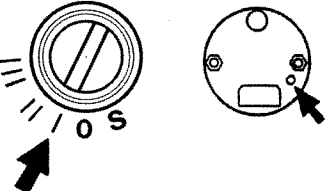
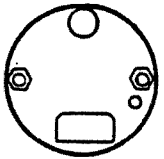
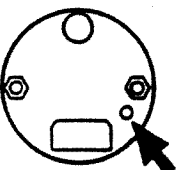
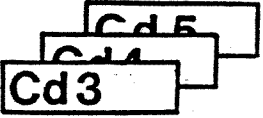
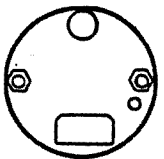
Setting step		Shown on display A	Descriptions
Disconnected from system voltage, press in pin B			
Connected to system voltage, press in pin B		<b>COdE</b>	
Remove pin B		<b>Cd6</b>	Displays current code (If the current code does not compare with code table, continue setting)
Press in pin B			Codes are scrolled at 1 second intervals
Remove pin B when correct code is displayed*		<b>Cd3</b>	This is your code (compare with code table)
<b>* = IMPORTANT Wait for 10 seconds with the unit connected to system voltage to confirm the code setting.</b>		<b>0.0</b>	Switches to hours counting

GER

Vor Benutzung des Drehzahlmessers ist der korrekte Code für den jeweiligen Motor einzustellen.

### ANWEISUNG ZUR CODE-EINSTELLUNG

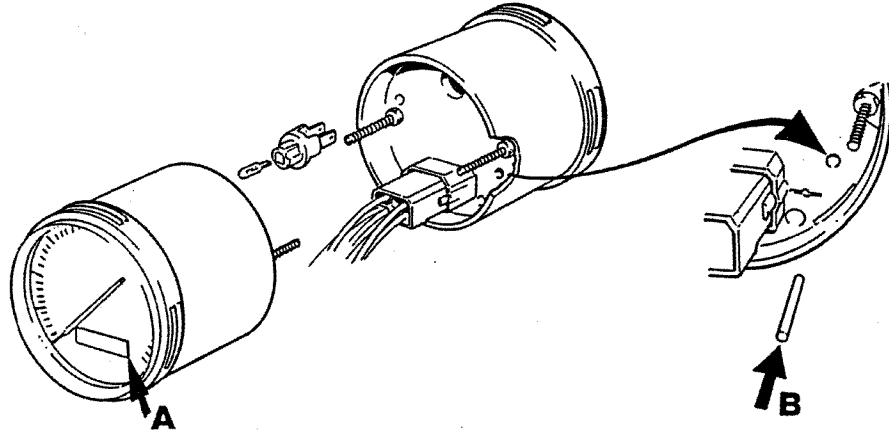

Einstellschritt		Anzeige auf Sichtfeld A	Beschreibung
Spannung AN		<b>CODE</b>	
Stift B hineindrücken und Stift B herausziehen (Stift B ist nicht im Drehzahlmessersatz eingeschlossen)		<b>Cd1</b>	
Stift B hineindrücken		<b>Cd3</b> <b>Cd4</b> <b>Cd5</b>	Die Aufzählung der Codes erfolgt im 1 Sekunden-Abstand
Stift B herausziehen, sobald der richtige Code erscheint*		<b>Cd3</b>	Das ist Ihr Code (Vergleich mit der Code-tabelle)
<b>* = WICHTIG! Bei eingeschalteter Spannung 10 Sekunden warten, bis der Code bestätigt wird</b>		<b>0.0</b>	Schaltet auf Stunden-zähleranzeige um

## ANWEISUNG FÜR DIE FEINEINSTELLUNG

(Vorgesehen für Doppeleinstellung, bei Bedarf auszuführen)

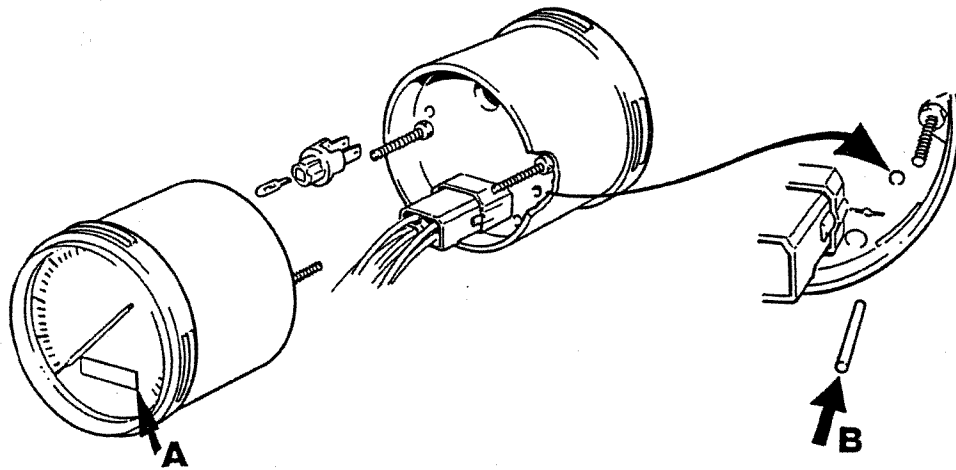







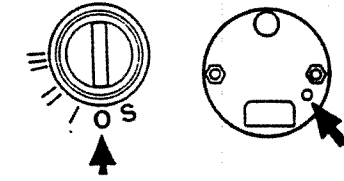

Einstellungsschritt		Anzeige auf dem Sichtfeld	Beschreibung
Spannung AN Stift B hineindrücken		<b>A 0,0</b>	A = Feineinstellverfahren
Stift B herausziehen		<b>A 0,0</b>	Zeigt aktuellen Unterschied zur Normaleinstellung
Stift B hineindrücken		<b>A 2,5</b> ↑	Zeiger bewegt sich nach oben. Das Sichtfeld zeigt den aktuellen Unterschied zur Normaleinstellung
Stift B herausziehen*		<b>A 2,5</b>	Zeigt aktuellen Unterschied zur Normaleinstellung
Stift B hereindrücken		<b>A -1,5</b> ↓	Zeiger bewegt sich nach unten. Das Sichtfeld zeigt den aktuellen Unterschied zur Normaleinstellung
Stift B herausziehen*		<b>A -1,5</b>	Zeigt den aktuellen Unterschied zur Normaleinstellung
* = WICHTIG! Bei eingeschalteter Spannung 10 Sekunden warten, bis der Code bestätigt wird		<b>0,0</b>	Schaltet auf Stunden-zähleranzeige um

**A 2,5**

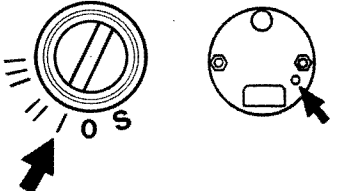
Diese Ziffer zeigt den Unterschied des aktuellen Skalenwertes in Prozent. Abstufung in 0,5-Einheiten.

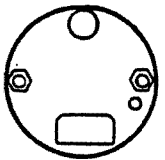

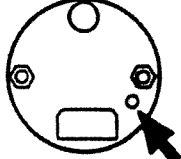
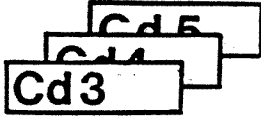
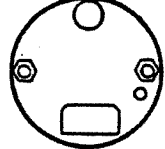
## ANWEISUNG ZUM ÄNDERN DES FRÜHER EINGESTELLTEN CODES

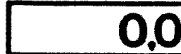
Installationsschritt		Anzeige auf Sichtfeld A	Beschreibung
Spannung AUS, Stift B hineindrücken			
Bei hineingedrücktem Stift B Spannung AN			
Stift B herausziehen			Zeigt aktuellen Code (stimmt der aktuelle Code nicht mit der Codetabelle überein, mit dem Ein- stellungsvorgang fortfah- ren).
Stift B hineindrücken			Die Codes werden im Abstand von 1 Sekunde aufgezählt.
Stift B herausziehen, sobald der korrekte Code erscheint*			Das ist Ihr Code (Vergleich mit der Codetabelle).
<p><b>* = WICHTIG! Bei eingeschalteter Spannung 10 Sekunden warten, bis der Code bestätigt wird</b></p>			Schaltet auf Stunden- zähleranzeige um

**FRE**

Avant d'utiliser le compte-tours, un code exact doit être donné suivant le moteur avec lequel il est utilisé.

**INSTRUCTIONS POUR LE REGLAGE DU CODE**

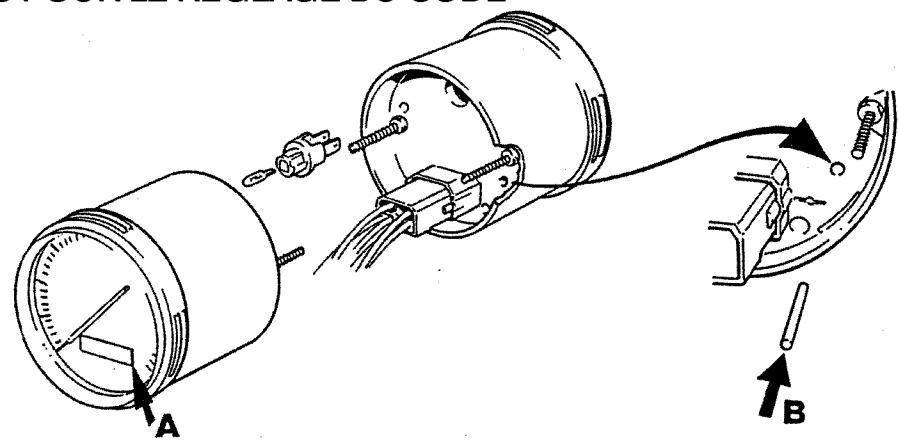

Etapas de réglage		Affichage A	Description
Contact mis.		<div style="border: 1px solid black; padding: 5px; display: inline-block;"><b>COdE</b></div>	
Enfoncez la tige B et relâchez la tige B. (La tige B ne fait pas partie du kit de compte-tours.)		<div style="border: 1px solid black; padding: 5px; display: inline-block;"><b>Cd1</b></div>	
Enfoncez la tige B.		<div style="border: 1px solid black; padding: 5px; display: inline-block;"><b>Cd3</b></div> <div style="border: 1px solid black; padding: 5px; display: inline-block; margin-left: 10px;"><b>Cd4</b></div> <div style="border: 1px solid black; padding: 5px; display: inline-block; margin-left: 10px;"><b>Cd5</b></div>	Le code augmente toute les secondes.
Enlevez la tige B lorsque le code exact est affiché*		<div style="border: 1px solid black; padding: 5px; display: inline-block;"><b>Cd3</b></div>	Voici votre code (comparez avec le tableau des codes).
* = IMPORTANT! Attendez 10 secondes avec le contact mis pour confirmer le code.		<div style="border: 1px solid black; padding: 5px; display: inline-block;"><b>0,0</b></div>	Passe à la fonction compteur d'heures.

# INSTRUCTIONS POUR UN REGLAGE DE PRECISION

(Prévu pour une double installation, à effectuer suivant les besoins)

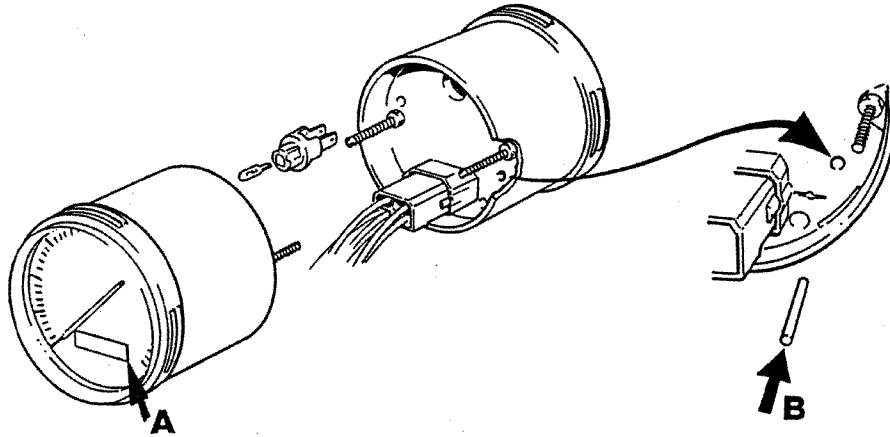





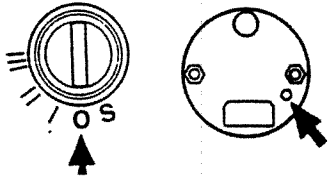
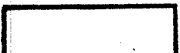
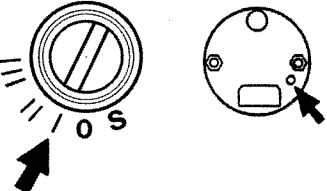

Etapes de réglage		Affichage	Description
Contact mis enfoncé la tige B.		<b>A 0,0</b>	A = mode réglage de précision
Enlevez la tige B.		<b>A 0,0</b>	Affiche la différence actuelle par rapport au réglage normal.
Enfoncé la tige B.		<b>A 2,5</b> ↑	L'affichage se déplace vers le haut, l'afficheur indique la différence actuelle par rapport au réglage normal.
Enlevez la tige B*		<b>A 2,5</b>	Affiche la différence actuelle par rapport au réglage normal.
Enfoncé la tige B.		<b>A -1,5</b> ↓	L'affichage se déplace vers le bas, l'afficheur indique la différence actuelle par rapport au réglage normal.
Enlevez la tige B*		<b>A -1,5</b>	Affiche la différence actuelle par rapport au réglage normal.
* = IMPORTANT! Attendez 10 secondes avec le contact mis pour confirmer le code.		<b>0,0</b>	Passe à la fonction compteur d'heures.

**A 2,5**

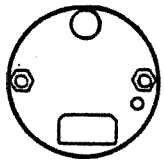
Ce chiffre indique la différence en pourcentage de l'échelle actuelle. Les chiffres sont donnés par paliers de 0,5.

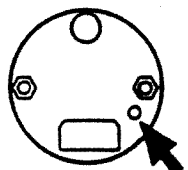
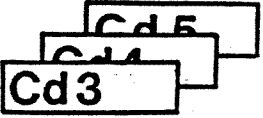
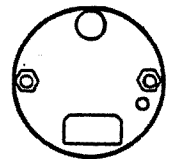
# INSTRUCTIONS POUR LA MODIFICATION D'UN CODE AJUSTE ANTERIEUREMENT

Etapes de réglage		Affichage A	Description
Contact coupé, enfoncez la tige B.			
Contact mis, tige B enfoncée.			
Enlevez la tige B.			Affiche le code actuel. (Si le code actuel ne correspond pas au tableau des codes, continuez le réglage.)
Enfoncez la tige B.			Le code augmente toutes les secondes.
Enlevez la tige B lorsque le code exact est * affiche			Voici votre code (comparez avec le tableau des codes).
* = IMPORTANT! Attendez 10 secondes avec le contact mis pour confirmer le code.			Passe à la fonction compteur d'heures.

SPA

Antes de utilizar el cuentarrevoluciones es necesario ajustar el código correcto correspondiente a cada motor.

### INSTRUCCIONES PARA EL AJUSTE DE CÓDIGO

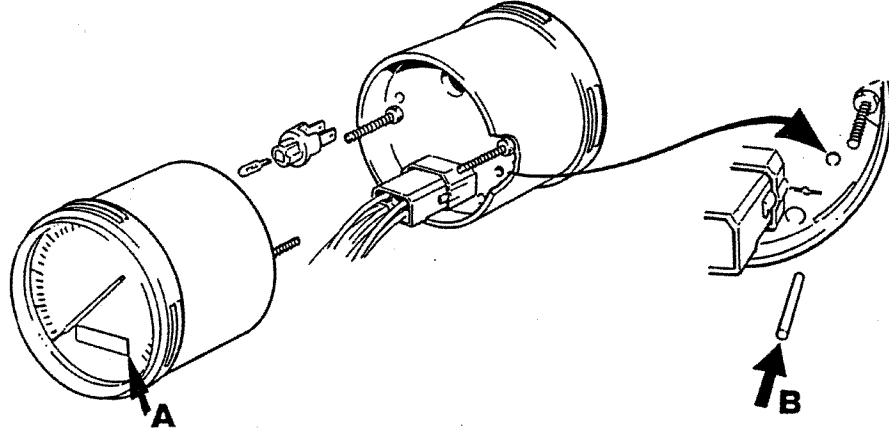

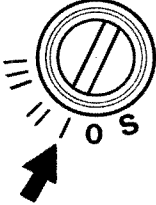
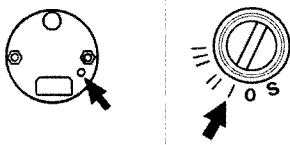
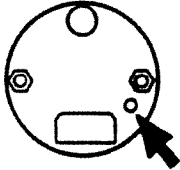
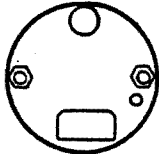
Etapas de ajuste		Aparece en el display A	Descripción
Dar paso a la corriente.		<div style="border: 1px solid black; padding: 5px; display: inline-block;">CODE</div>	
Presionar el perno B y soltarlo. (Este perno no va incluido en el kit del cuentarrevoluciones)		<div style="border: 1px solid black; padding: 5px; display: inline-block;">Cd1</div>	
Presionar el perno B.		<div style="border: 1px solid black; padding: 5px; display: inline-block;">Cd5</div> <div style="border: 1px solid black; padding: 5px; display: inline-block; margin-left: 20px;">Cd4</div> <div style="border: 1px solid black; padding: 5px; display: inline-block;">Cd3</div>	El código avanza a intervalos de un segundo.
Quitar el perno B cuando aparece en el display el código correcto*		<div style="border: 1px solid black; padding: 5px; display: inline-block;">Cd3</div>	Este es el código de usted, (compárelo con la tabla de códigos)
* = IMPORTANTE: Esperar 10 segundos con la corriente acoplada para que se confirme el código.		<div style="border: 1px solid black; padding: 5px; display: inline-block;">0.0</div>	Cambio a la indicación de cuentahoras

# INSTRUCCIONES PARA EL AJUSTE DE PRECISIÓN

(Para instalaciones dobles, se efectúa cuando es necesario)

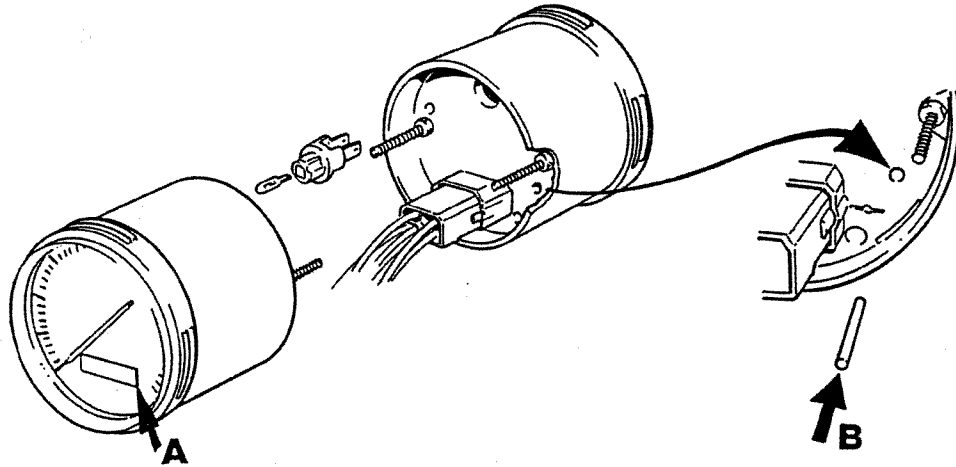







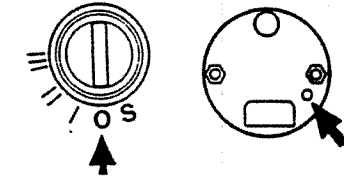

Etapas de ajuste		Aparece en el display	Descripción
Conectar tensión, presionar el perno B		<b>A 0,0</b>	A=Modo de ajuste de precisión
Quitar el perno B		<b>A 0,0</b>	Se indica la diferencia con el ajuste normal.
Introducir el perno B		<b>A 2,5</b> ↑	El indicador se desplaza hacia arriba, en el display se indica la diferencia con el ajuste normal.
Retirar el perno B*		<b>A 2,5</b>	Se indica la diferencia con el ajuste normal.
Introducir el perno B		<b>A -1,5</b> ↓	El indicador se desplaza hacia abajo, en el display se indica la diferencia con el ajuste normal.
Retirar el perno B*		<b>A -1,5</b>	Se indica la diferencia con el ajuste normal.
* = IMPORTANTE: Esperar 10 segundos con la corriente acoplada para que se confirme el código.		<b>0,0</b>	Se pasa al cuentahoras

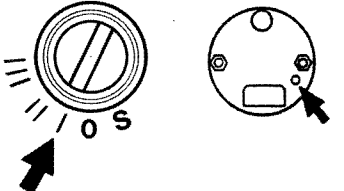
**A 2,5**

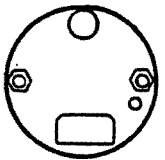
Esta cifra muestra la diferencia expresada en porcentaje del valor de escala en cuestión. Los intervalos entre las cifras son de 0,5.

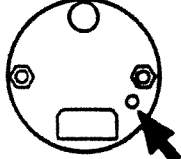
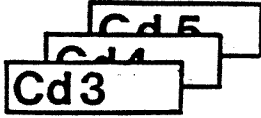
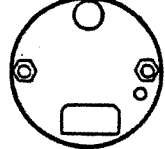
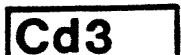
## INSTRUCCIONES PARA EL CAMBIO DE CÓDIGOS ANTERIORES

Etapas de ajuste		Aparece en el display	Descripción
Cortar la corriente, introducir el perno B.			
Conectar la corriente, perno B introducido.			
Retirar el perno B.			Indica el código en vigencia. (Si éste no coincide con el de la tabla de códigos, seguir con el ajuste).
Introducir el perno B.			Los códigos se incrementan a intervalos de un segundo.
Quitar el perno B cuando aparezca el código correcto*			Este será su código (compárelo con la tabla).
<p><b>* = IMPORTANTE: Esperar 10 segundos con la corriente acoplada para que se confirme el código.</b></p>			Se pasa al cuentahoras.

ITA

Prima di utilizzare il contagiri controllare che sia stato impostato il codice corrispondente al motore a cui va applicato.

### ISTRUZIONI PER L'IMPOSTAZIONE DEL CODICE

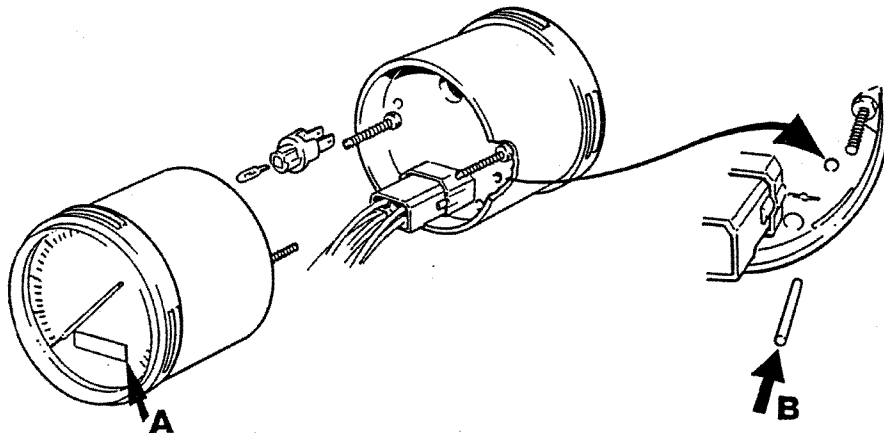

Fasi d'impostazione		Il display A mostra:	Descrizione
Tensione attivata		<b>COdE</b>	
Premere verso l'interno il perno B e rilasciare il perno B. (Il perno B non è compreso nel kit del contagiri)		<b>Cd1</b>	
Premere verso l'interno il perno B.		<b>Cd3</b> <b>Cd4</b> <b>Cd5</b>	I codici vengono calcolati con un secondo d'intervallo tra uno e l'altro.
Togliere il perno B quando viene visualizzato il codice corretto*		<b>Cd3</b>	Appare il codice corretto. (Controllare sulla tabella dei codici)
* = <b>IMPORTANTE!</b> Attendere 10 secondi con la tensione attivata, in modo che il codice venga confermato e memorizzato.		<b>0,0</b>	Collegare con il visualizzatore del contaore.



## ISTRUZIONI PER LA REGOLAZIONE FINE

(Prevista per le installazioni gemellari, da eseguire se necessario)

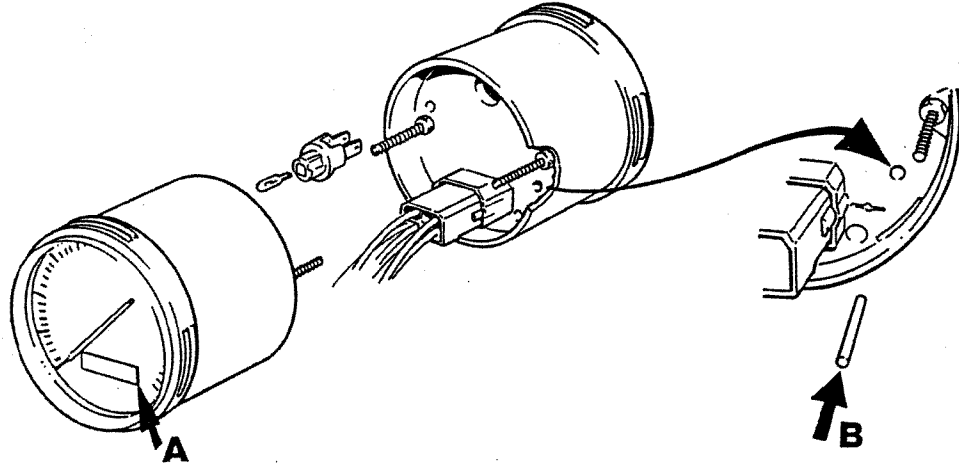

Fasi d'impostazione		Il display A mostra:	Descrizione
Tensione attivata, premere verso l'interno il perno B.		<b>A 0,0</b>	A = Modo di regolazione fine.
Togliere il perno B.		<b>A 0,0</b>	Mostra l'attuale differenza rispetto alla regolazione normale.
Premere verso l'interno il perno B.		<b>A 2,5</b> ↑	Il visualizzatore si porta su valori più alti. Il display mostra l'attuale differenza rispetto alla regolazione normale.
Togliere il perno B*		<b>A 2,5</b>	Mostra l'attuale differenza rispetto alla regolazione normale.
Premere verso l'interno il perno B.		<b>A -1,5</b> ↓	Il visualizzatore si porta su valori più bassi. Il display mostra l'attuale differenza rispetto alla regolazione normale.
Togliere il perno B*		<b>A -1,5</b>	Mostra l'attuale differenza rispetto alla regolazione normale.
<b>* = IMPORTANTE! Attendere 10 secondi con la tensione attivata, in modo che il codice venga confermato e memorizzato.</b>		<b>0,0</b>	Collegare con il visualizzatore del contatore.

**A 2,5**

Questa cifra mostra la differenza percentuale della scala attuale. Gli scatti in aumento o diminuzione sono di 0,5 unità.

## ISTRUZIONI PER LA MODIFICA DI UN CODICE PRECEDENTEMENTE MEMORIZZATO

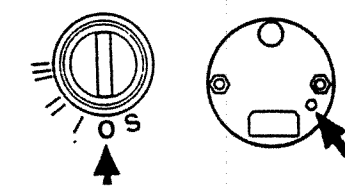
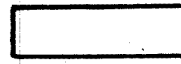
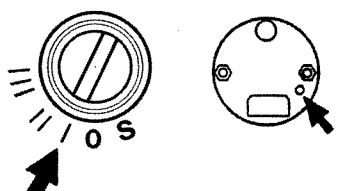
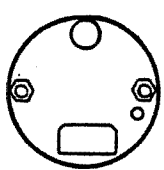
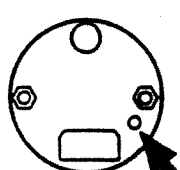
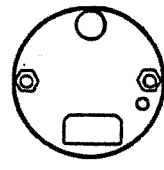
Fasi d'impostazione		Il display A mostra:	Descrizione
Tensione disattivata, premere verso l'interno il perno B.			
Tensione attivata, premere verso l'interno il perno B.		<b>COdE</b>	Mostra il codice attualmente memorizzato (se questo non corrisponde con quanto riportato nella tabella dei codici, procedere con la modifica).
Togliere il perno B.		<b>Cd6</b>	I codici vengono calcolati con un secondo d'intervallo tra l'uno e l'altro.
Premere verso l'interno il perno B.		<b>Cd3</b> <b>Cd4</b> <b>Cd5</b>	Appare il codice corretto. (Controllare sulla tabella dei codici)
Togliere il perno B quando viene mostrato il codice corretto*		<b>Cd3</b>	Collegare con il visualizzatore del contaore.
* = <b>IMPORTANTE!</b> Attendere 10 secondi con la tensione attivata, in modo che il codice venga confermato e memorizzato.		<b>0.0</b>	

SWE

Innan varvräknaren används måste rätt kod för respektive motor ställas in.

## INSTRUKTION FÖR KODINSTÄLLNING

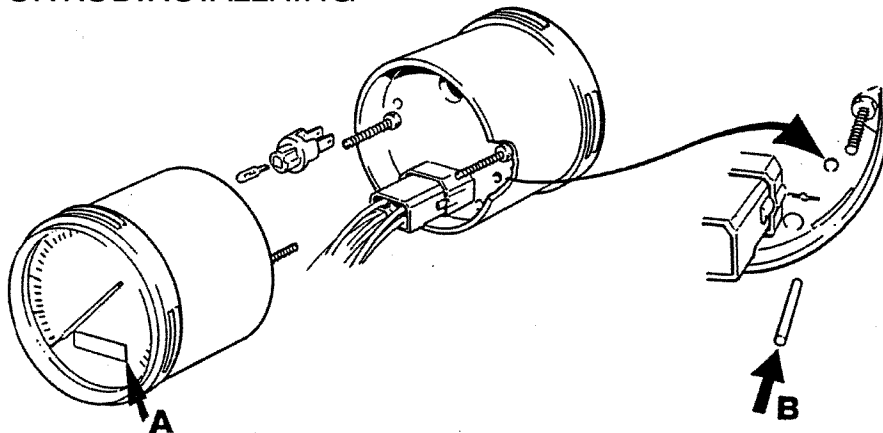

Inställningssteg		Visas på display A	Beskrivning
Spänning på.		<b>COdE</b>	
Tryck in pinne B och släpp pinne B. (Pinne B ingår ej i varvräknarsatsen)		<b>Cd1</b>	
Tryck in pinne B		<b>Cd3</b> <b>Cd4</b> <b>Cd5</b>	Koden räknas upp med en sekunds mellanrum
Ta bort pinne B när rätt kod visas*		<b>Cd3</b>	Detta är din kod, (jämför med kodtabellen)
* = VIKTIGT. Vänta 10 sekunder med spänning på så att koden blir bekräftad.		<b>0.0</b>	Kopplar över till timräknarvisning

# INSTRUKTION FÖR FINJUSTERING

(Avsedd för dubbelinstallation, utföres vid behov)

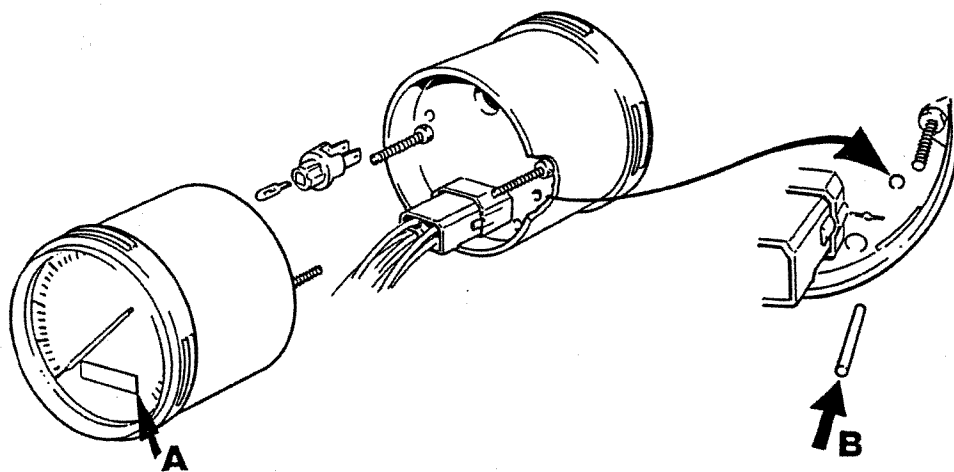







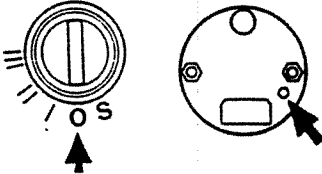

Inställningssteg		Visas på display	Beskrivning
Spänning på tryck in pinne B		<b>A 0,0</b>	A=Finjusteringsmode
Ta bort pinne B		<b>A 0,0</b>	Visar aktuell skillnad till normaljustering.
Tryck in pinne B		<b>A 2,5</b> ↑	Visaren rör sig uppåt, displayen visar aktuell skillnad till normaljustering.
Ta bort pinne B*		<b>A 2,5</b>	Visar aktuell skillnad till normaljustering.
Tryck in pinne B		<b>A -1,5</b> ↓	Visaren rör sig nedåt, displayen visar aktuell skillnad till normaljustering.
Ta bort pinne B*		<b>A -1,5</b>	Visar aktuell skillnad till normaljustering.
* = VIKTIGT. Vänta 10 sekunder med spänning på så att koden blir bekräftad.		<b>0,0</b>	Kopplar över till timräknarvisning

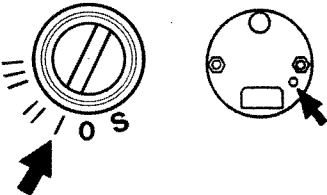
**A 2,5**

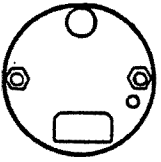
Denna siffra visar skillnaden i procent av aktuellt skalvärde. Stegen mellan siffrorna är 0,5.

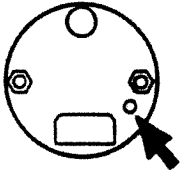
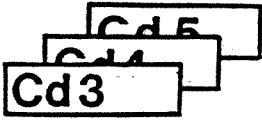
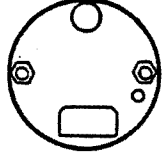
## INSTRUKTION FÖR ÄNDRING AV TIDIGARE INSTÄLLD KOD

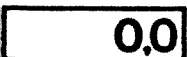
Inställningssteg		Visas på display A	Beskrivning
Spänning av, tryck in pinne B.			
Spänning på, intryckt pinne B			
Ta bort pinne B			Visar aktuell kod. (Om aktuell kod ej stämmer enligt kodtabellen, fortsätt inställningen.
Tryck in pinne B			Koden räknas upp med en sekunds mellanrum.
Ta bort pinne B när rätt kod visas*			Detta är din kod (jämför med kodtabellen).
* = VIKTIGT. Vänta 10 sekunder med spänning på så att koden blir bekräftad.			Kopplar över till timräknarvisning.





**VOLVO  
PENTA**

AB Volvo Penta